

TP-LINK®

User Guide

TD-8811

ADSL2+ Modem Router



COPYRIGHT & TRADEMARKS

Specifications are subject to change without notice. **TP-LINK®** is a registered trademark of TP-LINK TECHNOLOGIES CO., LTD. Other brands and product names are trademarks or registered trademarks of their respective holders.

No part of the specifications may be reproduced in any form or by any means or used to make any derivative such as translation, transformation, or adaptation without permission from TP-LINK TECHNOLOGIES CO., LTD. Copyright © 2009 TP-LINK TECHNOLOGIES CO., LTD.

All rights reserved.

<http://www.tp-link.com>

FCC STATEMENT



This equipment has been tested and found to comply with the limits for a Class B digital device, pursuant to part 15 of the FCC Rules. These limits are designed to provide reasonable protection against harmful interference in a residential installation. This equipment generates, uses and can radiate radio frequency energy and, if not installed and used in accordance with the instructions, may cause harmful interference to radio communications. However, there is no guarantee that interference will not occur in a particular installation. If this equipment does cause harmful interference to radio or television reception, which can be determined by turning the equipment off and on, the user is encouraged to try to correct the interference by one or more of the following measures:

- Reorient or relocate the receiving antenna.
- Increase the separation between the equipment and receiver.
- Connect the equipment into an outlet on a circuit different from that to which the receiver is connected.
- Consult the dealer or an experienced radio/ TV technician for help.

CE Mark Warning



This is a class B product. In a domestic environment, this product may cause radio interference, in which case the user may be required to take adequate measures.

EC DECLARATION OF CONFORMITY (EUROPE)

In compliance with the EMC Directive 89/336/EEC, Low Voltage Directive 73/23/EEC, this product meets the requirements of the following standards:

- EN55022
- EN55024
- EN60950

SAFETY NOTICES

Caution:

Do not use this product near water, for example, in a wet basement or near a swimming pool.

CONTENTS

Package Contents	1
Chapter 1. Introduction	2
1.1 Product Overview	2
1.2 Main Features	2
1.3 Supporting Protocol.....	2
1.4 Transmit Data-rate	3
1.5 ATM Property	3
1.6 System Support.....	3
1.7 Working Environment.....	3
1.8 Conventions	3
Chapter 2. Hardware Installation	5
2.1 System Requirement.....	5
2.1.1 LED explanation	5
2.2 Rear-panel	6
2.3 Hardware Installation Procedures	6
Chapter 3. Quick Installation Guide	8
3.1 Computer Configuration	8
3.2 Login	12
3.3 Quick Setup.....	13
3.3.1 PPPoA.....	14
3.3.2 PPPoE.....	16
3.3.3 MER.....	19
3.3.4 IPoA.....	22
3.3.5 Bridging	24
3.4 Change Password.....	26
3.5 DHCP IP Reservation	28
3.6 USB Configuration	30
Chapter 4. Web-based Configuration.....	34
4.1 Device Info	34
4.2 Quick Setup.....	34
4.3 Advanced Setup.....	34
4.3.1 WAN	35
4.3.2 LAN.....	46
4.3.3 MAC Clone	49

4.3.4	Security.....	50
4.3.5	Routing.....	54
4.3.6	DSL.....	56
4.4	Diagnostics.....	58
4.5	Management.....	59
4.5.1	Settings.....	59
4.5.2	System Log.....	61
4.5.3	SNMP Agent.....	63
4.5.4	Access Control.....	63
4.5.5	Update Firmware.....	66
4.5.6	Save/Reboot.....	66
Chapter 5.	Software Dial.....	68
Appendix A:	FAQ.....	71
Appendix B:	Default Config.....	73

Package Contents

The following items should be found in your package:

- One TD-8811 ADSL2+ Modem Router
- One Power Adapter for TD-8811 ADSL2+ Modem Router
- One Resource CD for TD-8811 ADSL2+ Modem Router, including:
 - This Guide
 - Quick installation Guide Program
 - Other Helpful Information
- Quick installation Guide
- One RJ45 cable
- Two RJ11 cables
- One USB cable
- One ADSL splitter

 **Note:**

Make sure that the package contains the above items. If any of the listed items are damaged or missing, please contact with your distributor.

Chapter 1. Introduction

Thank you for choosing the TD-8811 ADSL2+ Modem Router.

1.1 Product Overview

With the excellent circuit design and high quality production, we guarantee the ADSL Router's high performance, great stability and easy to use.

The TD-8811 uses integrated ADSL transceiver. The AFE supports full-rate ADSL connectivity conforming to the ITU and ANSI specifications.

In addition to the basic DMT physical layer functions, the ADSL PHY supports dual latency ADSL framing (fast and interleaved) and the I.432 ATM Physical Layer.

The TD-8811 is a complete plug-and-play solution. With standard Ethernet interface, it can be directly connected to any 10M/100M Ethernet devices, support Auto-MDIX.

The TD-8811 not only uses html (web mode through Ethernet port) to configure the Router but also uses external utility software. You can download it from our website (<http://www.tp-link.com>).

1.2 Main Features

- High speed and asymmetry data transmit mode, provides safe and exclusive bandwidth
- Support All ADSL industrial standards
- Compatible with all mainstream DSLAM (CO)
- Firmware upgradeable
- Provide integrated access of internet and route function which face to SOHO user
- Advanced DMT modulation and demodulation
- Real-time Configuration and device monitoring
- Quick response semi-conductive surge protect circuit, provides reliable ESD and surge-protect function
- Supports ADSL dual latency (fast path and interleaved path)

1.3 Supporting Protocol

- ANSI T1.413
- G.992.1 (G.dmt) - Annex A
- G.992.2 (G.lite) - Annex A
- G.992.3 (ADSL2) - Annex A and Annex L (RE-DSL) compliant
- G.992.5 (ADSL2+) - Annex A and Annex L (RE-DSL) compliant

- I.432 ATM physical layer compliant
- Supports RFC2364 (PPPoA)
- Supports RFC2516 (PPPoE)
- Supports RFC1483 (EoA) (Bridged *and Router)
- Supports RFC1577 (IPoA)

 **Note:**

“*” needs the third-party software.

1.4 Transmit Data-rate

- Max download data-rate: 24Mbps
- Max upload data-rate: 3.5Mbps
- Max line length: 6Km

1.5 ATM Property

- AAL0, AAL5, OAM, RM, and raw cell types supported
- Direct hardware support for 4 Receive VCs, with additional RX VCs and TX VCs supported in software
- Full 24-bit Virtual Path Identifier (VPI) and Virtual Circuit Identifier (VCI)

1.6 System Support

- Support PVC
- Support NAT、DHCP and so on
- Support IEEE 802.3、IEEE 802.3u
- Support 10Base-T/100BASE-TX full-duplex or half duplex Ethernet
- Support Auto-MDIX

1.7 Working Environment

- Operating temperature: 0 °C~40 °C
- Storage temperature: -40 °C~70 °C
- Humidity: 10%~90% (non-condensing)

1.8 Conventions

The Router or TD-8811, or device mentioned in this User Guide stands for TD-8811 ADSL2+

Modem Router without any explanations.

Parameters provided in the pictures are just references for setting up the product, which may differ from the actual situation.

You can set the parameters according to your demand.

Chapter 2. Hardware Installation

The TD-8811 maintains three separate interfaces, one Ethernet, one ADSL and one power adapter interface.

The Router should not be located where it will be exposed to moisture or excessive heat.

Place the Router in a location where it can be safely connected to the various devices as well as to a power source.

2.1 System Requirement

Confirm your computer has been installed with networking interface card (NIC) before connecting ADSL Router to your computer, with operating system supporting the TCP/IP protocol.

2.1.1 LED explanation

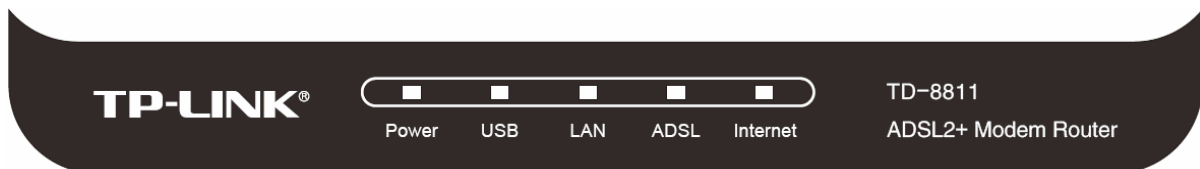

The front panel of ADSL Router includes one power indicator and four function indicators, as explained in the table below:

Name	Status	Indication
Power	On	Power is on.
	Off	Power is off.
USB	On	There is a successful connection on USB port but no activity.
	Flash	Data is being transferred over the USB connection.
	Off	There is no connection on USB port or the connection is abnormal.
LAN	On	There is a successful connection on the LAN port but no activity.
	Flash	Data is being transferred over the LAN port
	Off	There is no connection on the LAN port or the connection is abnormal.
ADSL	On	The LINE port is linked up.
	Flash	The ADSL negotiation is in progress.
	Off	The LINE port is linked down.
Internet	On	A successful PPP connection has been built.
	Flash	Data is being transferred over the Internet on PPP mode.
	Off	There is no successful PPP connection or the Router works on Bridge mode.

2.2 Rear-panel

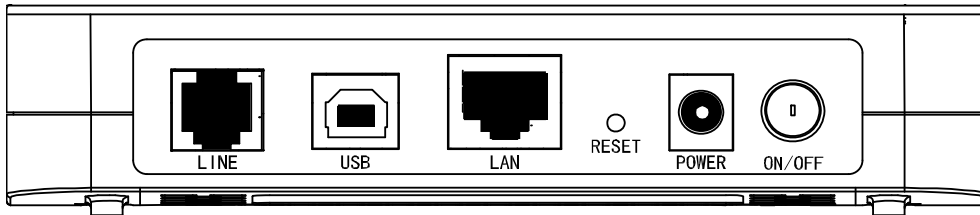

- **ON/OFF:** Turn on/off the ADSL Router's power.
- **POWER:** Please use the provided power adaptor, otherwise may cause damage to the ADSL Router.
- **RESET (reset default):** Press the **RESET** button and hold for five seconds and then wait for the router to reboot to its factory default settings.
- **LAN:** Connect to your computer with RJ45 cable.
- **USB:** Connect with your computer's USB interface.
- **LINE (WAN):** Connect to the MODEM Port of Splitter or Connect with the telephone line.

2.3 Hardware Installation Procedures

The procedure to install the Router can be described in the following steps:

First Step: Connect the MODEM port of Splitter with the LINE port of the TD-8811 ADSL2+ Modem Router by telephone line.

Second Step: Connect category 5 cable with RJ45 jacks to ADSL2+ Modem Router's LAN port and your computer's NIC. Or connect USB cable to ADSL2+ Modem Router's USB port and your computer's USB interface.

Third Step: Plug one end of the AC Power Adapter into the Power jack on the Ethernet ADSL2+ Modem Router and the other end to a standard electrical outlet.

Last Step: Check the line connection to see if everything is ready. Power up finally.

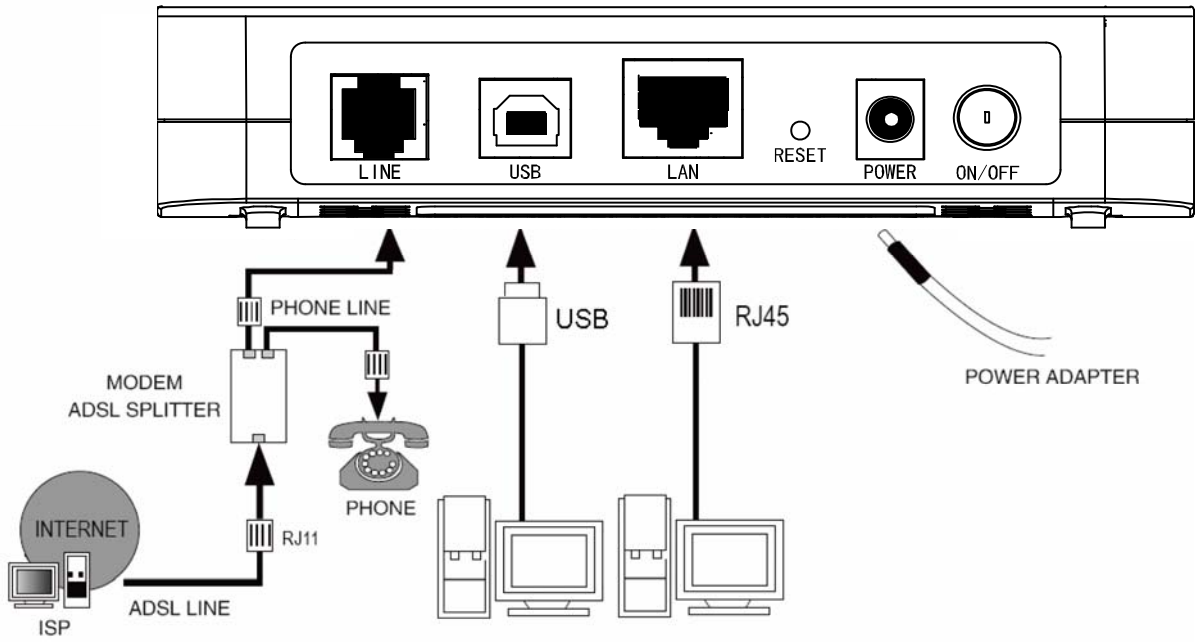

Figure 2-1

Chapter 3. Quick Installation Guide

3.1 Computer Configuration

After you directly connect your PC to the TD-8811 or connect your adapter to a Hub/Switch which has connected to the Router, you need to configure your PC's IP address. Now you have two ways to configure the TCP/IP protocol below:

➤ **Setting IP address automatically**

Step 1: Click the **Start** menu on your desktop, right click **My Network Places**, and then select **Properties** (shown in Figure 3-1).

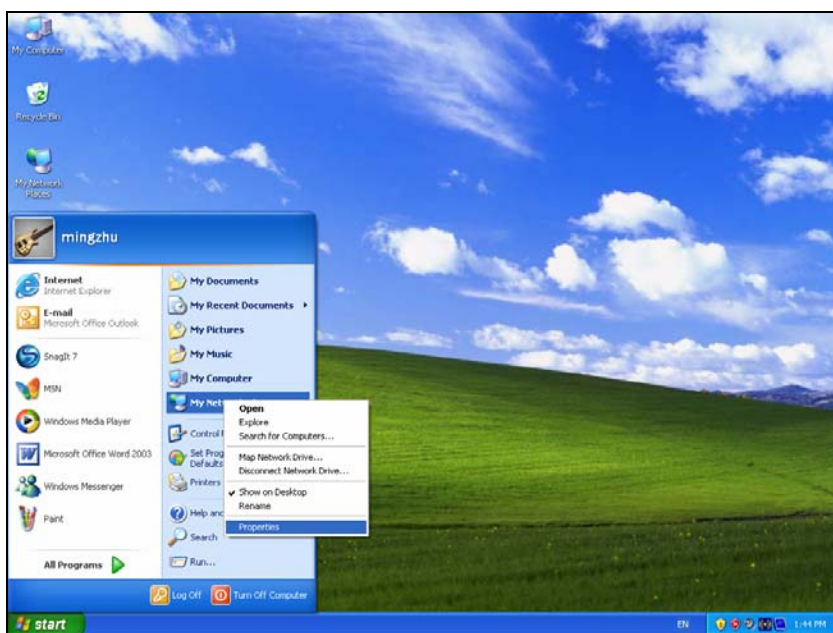

Figure 3-1

Step 2: Right click **Local Area Connection (LAN)**, and then select **Properties**.

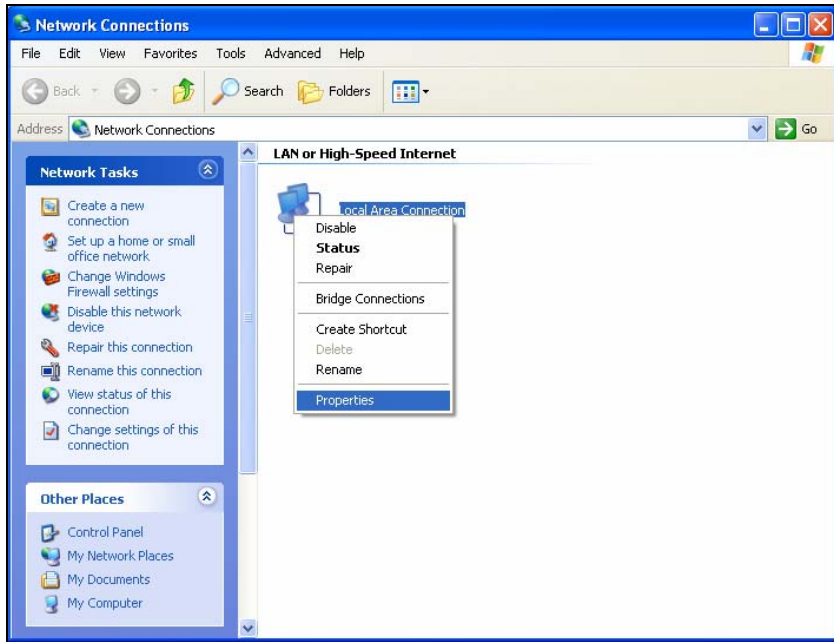

Figure 3-2

Step 3: Select **General** tab, highlight Internet Protocol (TCP/IP), and then click the **Properties** button.

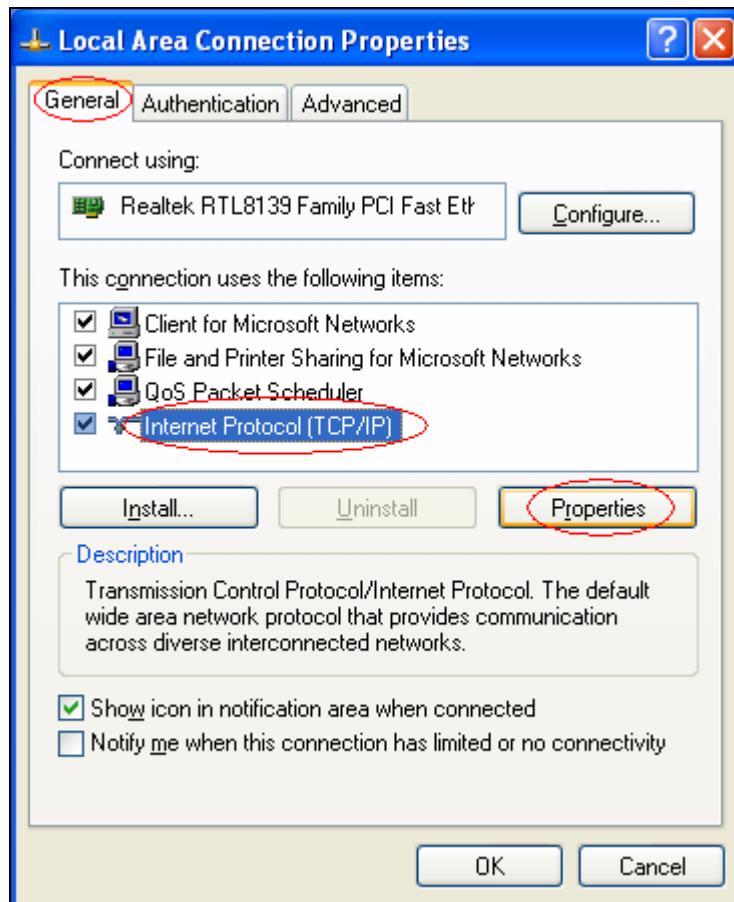

Figure 3-3

Step 4: Select “Obtain an IP address automatically” and “Obtain DNS server address automatically” in the screen below. And then click **OK**.

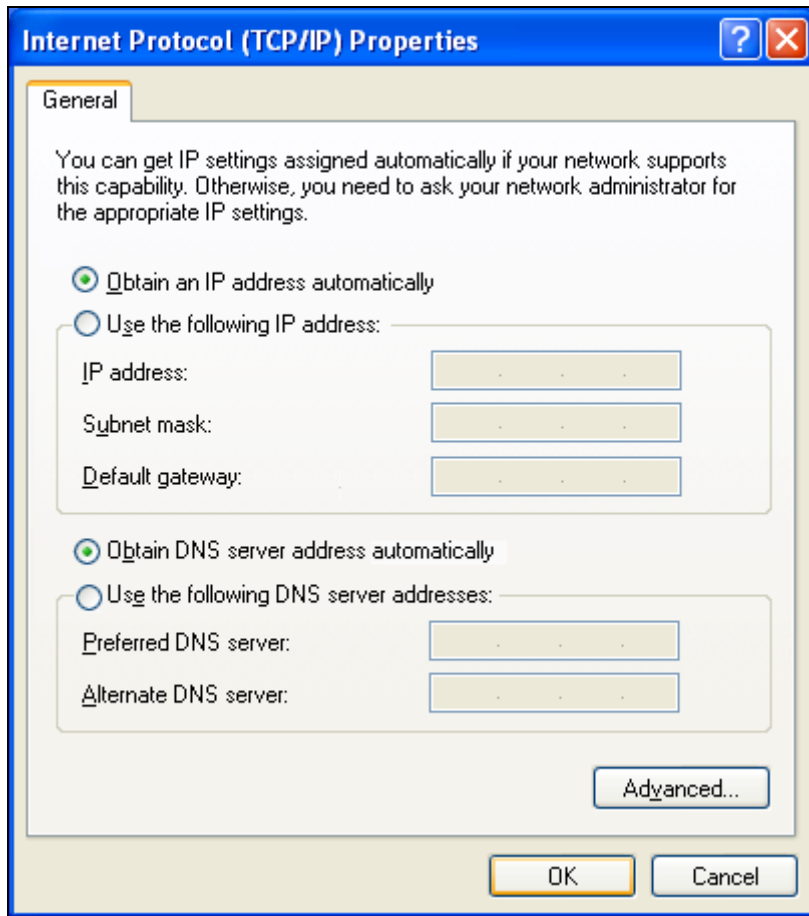

Figure 3-4

➤ **Setting IP address manually**

The default IP address of the ADSL2+ Modem Router is 192.168.1.1, and the default Subnet Mask is 255.255.255.0. These values can be seen from the LAN, and can be changed as your desire. As an example, we use the default values for description in this guide.

Step 1: Select **Use the following IP address** radio button in the next screen.

Step 2: Enter the IP address as 192.168.1.* (* is any value between 2 to 254). The **Subnet mask** is 255.255.255.0. Then type the ADSL Router’s LAN IP address 192.168.1.1 into the **Default gateway** field.

Step 3: Select **Use the following DNS server addresses** radio button. In the **Preferred DNS Server** field you can enter the same value as the **Default gateway** or type the local DNS server IP address.

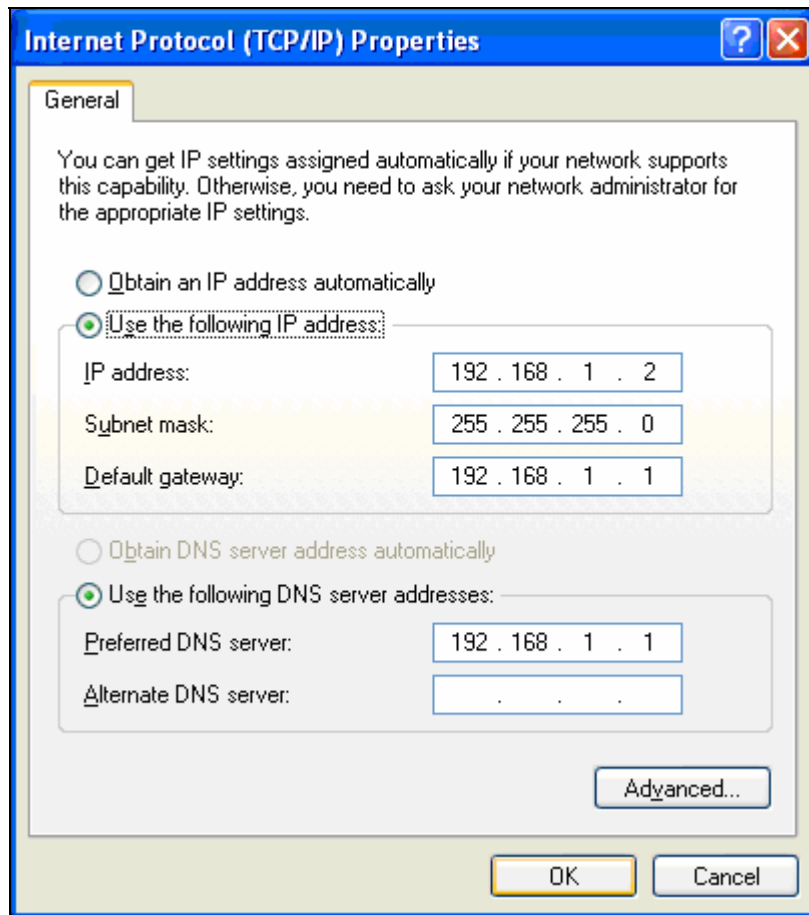

Figure 3-5

Note:

- 1) Users of Windows 98 can open **TCP/IP Properties** according to the following: Right-click (Mouse) **Network Neighbor** → Choose **Properties** → Double-click **TCP/IP**.
- 2) Users of Windows 2000/NT/XP can do the following: Right-click **Network Neighbor** → Choose **Properties** → Right-click **Local Connection** → Choose **Properties** → Double-click **Internet Protocol (TCP/IP)**.
- 3) The words in fact may be different with this guide.

Now, you can run the Ping command in the command prompt to verify the network connection. Please click the **Start** menu on your desktop, select **Run** tab, type **cmd** in the field, and then type *ping 192.168.1.1* on the next screen, and then press **Enter**.

If the screen looks like the following, you have been successful.

```

Pinging 192.168.1.1 with 32 bytes of data:

Reply from 192.168.1.1: bytes=32 time<1ms TTL=64
Reply from 192.168.1.1: bytes=32 time<1ms TTL=64
Reply from 192.168.1.1: bytes=32 time<1ms TTL=64
Reply from 192.168.1.1: bytes=32 time<1ms TTL=64

Ping statistics for 192.168.1.1:
    Packets: Sent = 4, Received = 4, Lost = 0 (0% loss),
Approximate round trip times in milli-seconds:
    Minimum = 0ms, Maximum = 0ms, Average = 0ms

```

Figure 3-6

If the screen looks like the following, the connection has failed. Please try again.

```

Pinging 192.168.1.1 with 32 bytes of data:

Request timed out.
Request timed out.
Request timed out.
Request timed out.

Ping statistics for 192.168.1.1:
    Packets: Sent = 4, Received = 0, Lost = 4 (100% loss),

```

Figure 3-7

3.2 Login

Startup Internet Explorer, and enter 192.168.1.1; then enter default user name (admin), password (admin). When ADSL connection is OK, the following login box will pop up.



Figure 3-8

3.3 Quick Setup

Figure 3-9 is the main page of the Router.

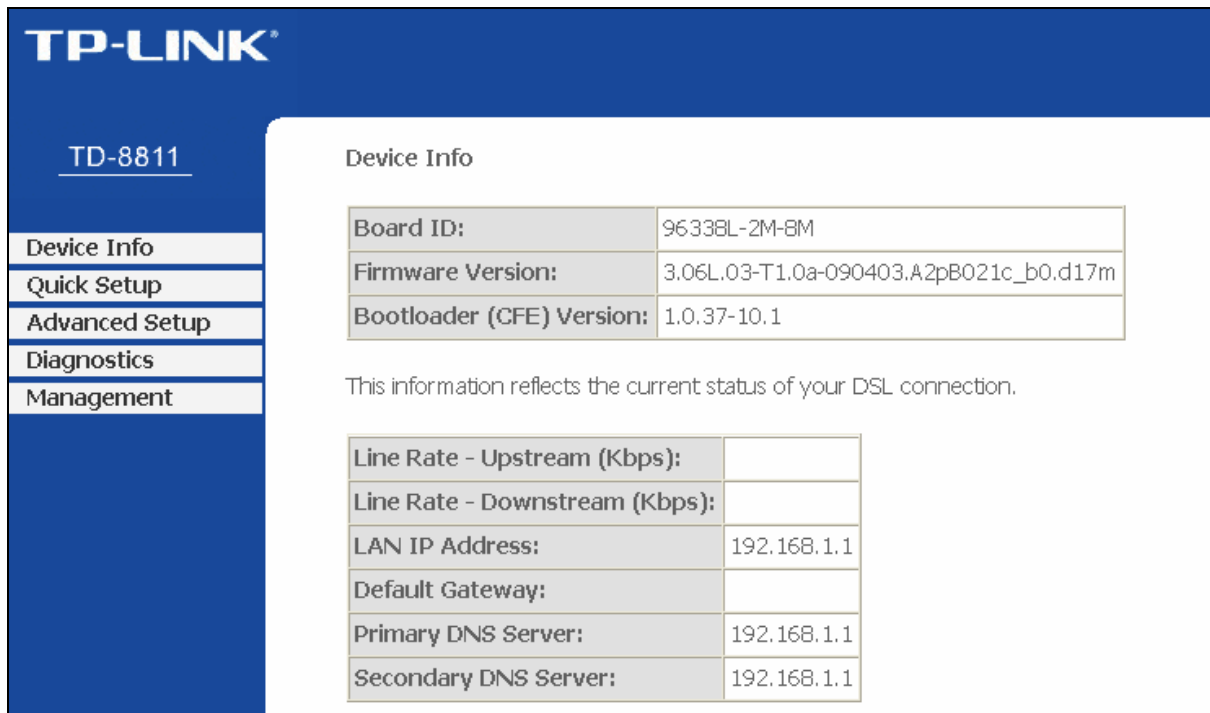

Figure 3-9

Please select **Quick Setup**. Enter the **VPI** and **VCI** values provided by your Internet Service Provider and click **Next**.

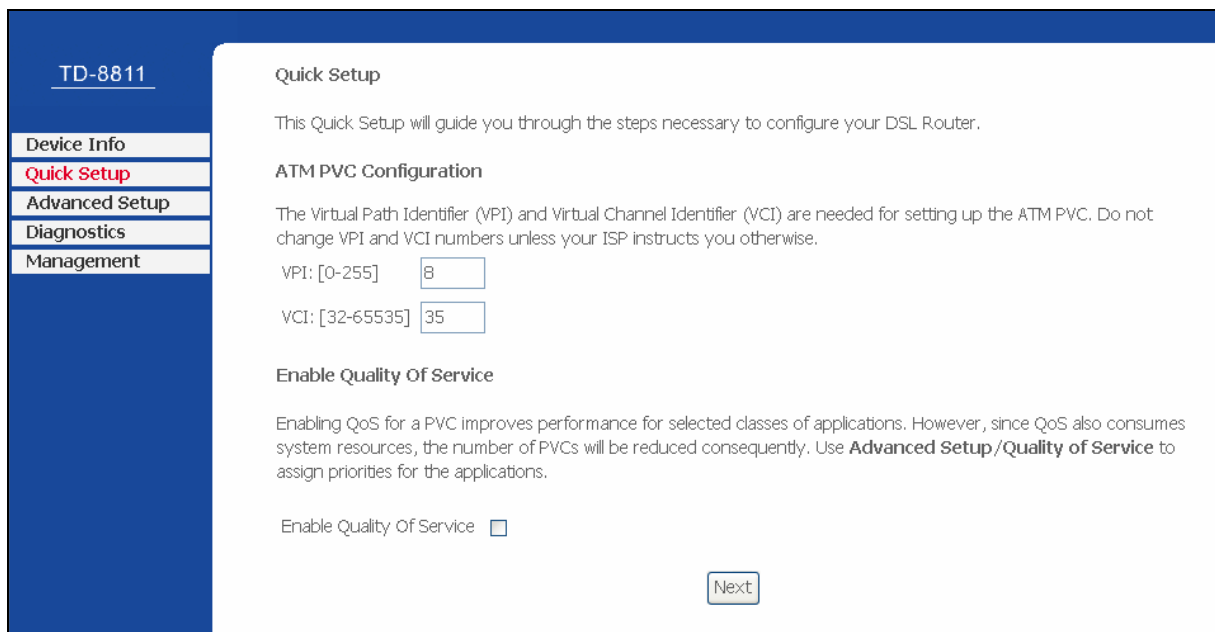

Figure 3-10

Select the relevant Connection Type and Encapsulation mode as the settings provided by your Internet Service Provider and click **Next**.

3.3.1 PPPoA

- a) Select PPP over ATM (PPPoA) Connection Type, and click **Next**.

The screenshot shows the configuration interface for the TD-8811 modem router. On the left is a blue sidebar with a menu containing: **TD-8811**, **Device Info**, **Quick Setup**, **Advanced Setup**, **Diagnostics**, and **Management**. The main content area is titled "Connection Type" and includes the instruction: "Select the type of network protocol for IP over Ethernet as WAN interface". There are five radio button options: **PPP over ATM (PPPoA)** (selected), **PPP over Ethernet (PPPoE)**, **MAC Encapsulation Routing (MER)**, **IP over ATM (IPoA)**, and **Bridging**. Below this is the "Encapsulation Mode" section with a dropdown menu currently set to "VC/MUX". At the bottom right of the main area are two buttons: "Back" and "Next".

Figure 3-11

- b) Enter the Username and Password provided by your Internet Service Provider and click **Next**.

PPP Username and Password

PPP usually requires that you have a user name and password to establish your connection. In the boxes below, enter the user name and password that your ISP has provided to you.

PPP Username:

PPP Password:

Authentication Method: **AUTO**

MTU [512-1500] :

Dial on demand (with idle timeout timer)

Inactivity Timeout (minutes) [1-4320]:

PPP IP extension

Use Static IP Address

Enable PPP Debug Mode

Figure 3-12

c) Click **Save/Reboot**.

WAN Setup - Summary

Make sure that the settings below match the settings provided by your ISP.

VPI / VCI:	8 / 35
Connection Type:	PPPoA
Service Name:	br_8_35
Service Category:	UBR
IP Address:	Automatically Assigned
Service State:	Enabled
NAT:	Enabled
Firewall:	Enabled
IGMP Multicast:	Enabled
Quality Of Service:	Disabled

Click "Save/Reboot" to save these settings and reboot router. Click "Back" to make any modifications.

NOTE: The configuration process takes about 1 minute to complete and your DSL Router will reboot.

[Back](#) [Save/Reboot](#)

Figure 3-13

3.3.2 PPPoE

- a) Select PPP over Ethernet (PPPoE) Connection Type, and click **Next**.

The screenshot shows the TD-8811 web interface. On the left is a blue sidebar with a menu containing: **TD-8811**, **Device Info**, **Quick Setup**, **Advanced Setup**, **Diagnostics**, and **Management**. The main content area is white and titled "Connection Type". Below the title is the instruction: "Select the type of network protocol for IP over Ethernet as WAN interface". There are five radio button options: "PPP over ATM (PPPoA)", "PPP over Ethernet (PPPoE)" (which is selected), "MAC Encapsulation Routing (MER)", "IP over ATM (IPoA)", and "Bridging". Below these is the "Encapsulation Mode" section with a dropdown menu currently set to "LLC/SNAP-BRIDGING". At the bottom right of the main area are two buttons: "Back" and "Next".

Figure 3-14

- b) Enter the Username and Password provided by your Internet Service Provider and click **Next**.

PPP Username and Password

PPP usually requires that you have a user name and password to establish your connection. In the boxes below, enter the user name and password that your ISP has provided to you.

PPP Username:

PPP Password:

PPPoE Service Name:

Authentication Method: ▼

MTU [512-1500] :

Dial on demand (with idle timeout timer)

Inactivity Timeout (minutes) [1-4320]:

PPP IP extension

Use Static IP Address

Enable PPP Debug Mode

Figure 3-15

- c) Click **Save/Reboot**.

WAN Setup - Summary

Make sure that the settings below match the settings provided by your ISP.

VPI / VCI:	8 / 35
Connection Type:	PPPoE
Service Name:	br_8_35
Service Category:	UBR
IP Address:	Automatically Assigned
Service State:	Enabled
NAT:	Enabled
Firewall:	Enabled
IGMP Multicast:	Enabled
Quality Of Service:	Disabled

Click "Save/Reboot" to save these settings and reboot router. Click "Back" to make any modifications.

NOTE: The configuration process takes about 1 minute to complete and your DSL Router will reboot.

Figure 3-16

 **Note:**

The Router will restart when you complete the configuration, so you have to wait for a while until it restarts successfully.

3.3.3 MER

- a) Select MAC Encapsulation Routing (MER) Connection Type, and click **Next**.

The screenshot shows the TD-8811 web interface. On the left is a blue sidebar with a menu containing: TD-8811, Device Info, Quick Setup, Advanced Setup, Diagnostics, and Management. The main content area is white and titled "Connection Type". Below the title is the instruction: "Select the type of network protocol for IP over Ethernet as WAN interface". There are five radio button options: PPP over ATM (PPPoA), PPP over Ethernet (PPPoE), MAC Encapsulation Routing (MER) (which is selected), IP over ATM (IPoA), and Bridging. Below these is the "Encapsulation Mode" section with a dropdown menu currently set to "LLC/SNAP-BRIDGING". At the bottom right of the main area are "Back" and "Next" buttons.

- b) Enter the parameter and the way which is provided by your ISP, then click **Next**.

WAN IP Settings

Enter information provided to you by your ISP to configure the WAN IP settings.

Notice: DHCP can be enabled for PVC in MER mode or IP over Ethernet as WAN interface if "Obtain an IP address automatically" is chosen. Changing the default gateway or the DNS effects the whole system. Configuring them with static values will disable the automatic assignment from DHCP or other WAN connection.

If you configure static default gateway over this PVC in MER mode, you must enter the IP address of the remote gateway in the "Use IP address". The "Use WAN interface" is optional.

Obtain an IP address automatically

Use the following IP address:

WAN IP Address:

WAN Subnet Mask:

Obtain default gateway automatically

Use the following default gateway:

Use IP Address:

Use WAN Interface:

Obtain DNS server addresses automatically

Use the following DNS server addresses:

Primary DNS server:

Secondary DNS server:

Figure 3-17

c) Click **Save/Reboot**.

WAN Setup - Summary

Make sure that the settings below match the settings provided by your ISP.

VPI / VCI:	8 / 35
Connection Type:	MER
Service Name:	br_8_35
Service Category:	UBR
IP Address:	Automatically Assigned
Service State:	Enabled
NAT:	Enabled
Firewall:	Enabled
IGMP Multicast:	Enabled
Quality Of Service:	Disabled

Click "Save/Reboot" to save these settings and reboot router. Click "Back" to make any modifications.

NOTE: The configuration process takes about 1 minute to complete and your DSL Router will reboot.

Figure 3-18

3.3.4 IPoA

- a) Select IP over ATM (IPoA) Connection Type, and click **Next**.

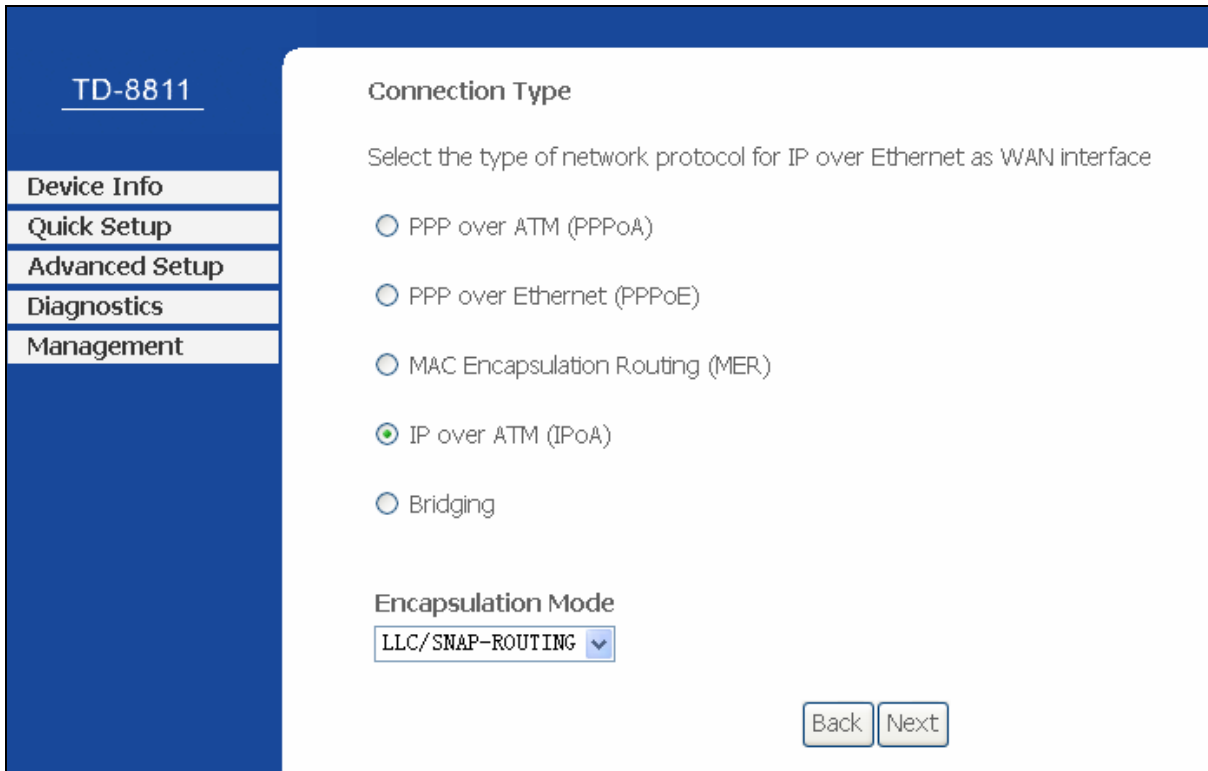

Figure 3-19

b) Enter the parameter and the way which is provided by your ISP, then click **Next**.

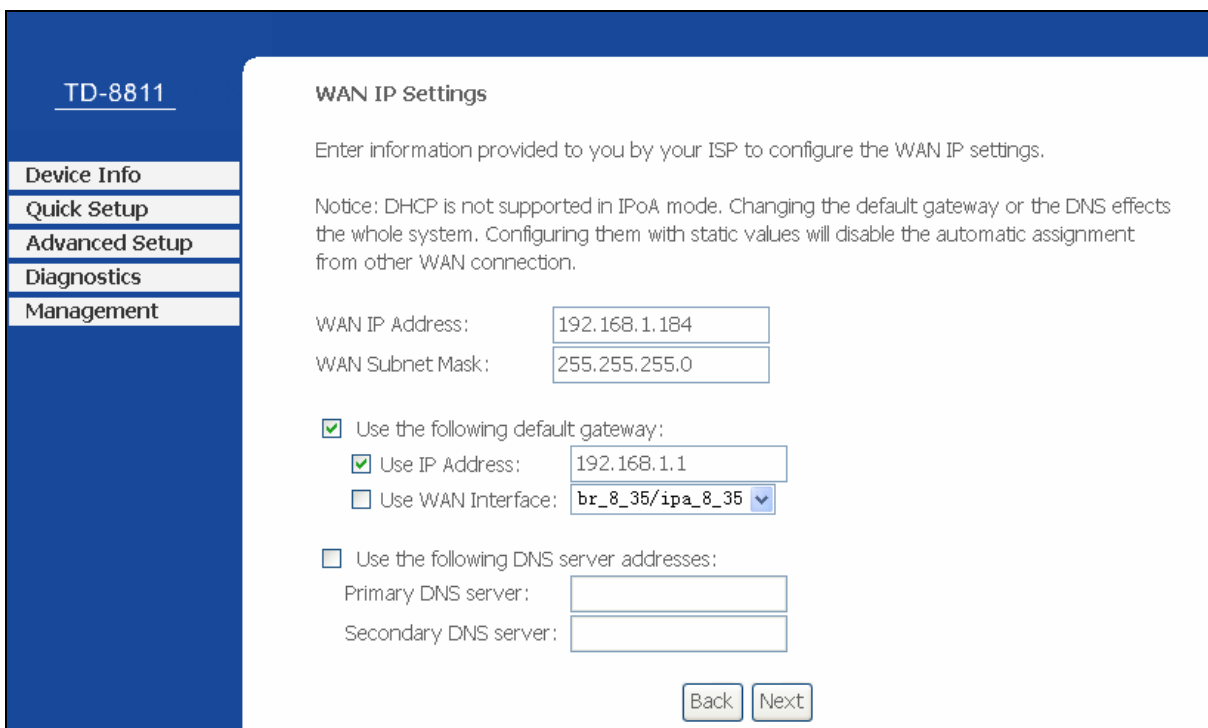

Figure 3-20

c) Click **Save/Reboot**.

WAN Setup - Summary

Make sure that the settings below match the settings provided by your ISP.

VPI / VCI:	8 / 35
Connection Type:	IPoA
Service Name:	br_8_35
Service Category:	UBR
IP Address:	192.168.1.184
Service State:	Enabled
NAT:	Enabled
Firewall:	Enabled
IGMP Multicast:	Enabled
Quality Of Service:	Disabled

Click "Save/Reboot" to save these settings and reboot router. Click "Back" to make any modifications.

NOTE: The configuration process takes about 1 minute to complete and your DSL Router will reboot.

Figure 3-21

3.3.5 Bridging

- a) Select **Bridging** Connection Type, and click **Next**.

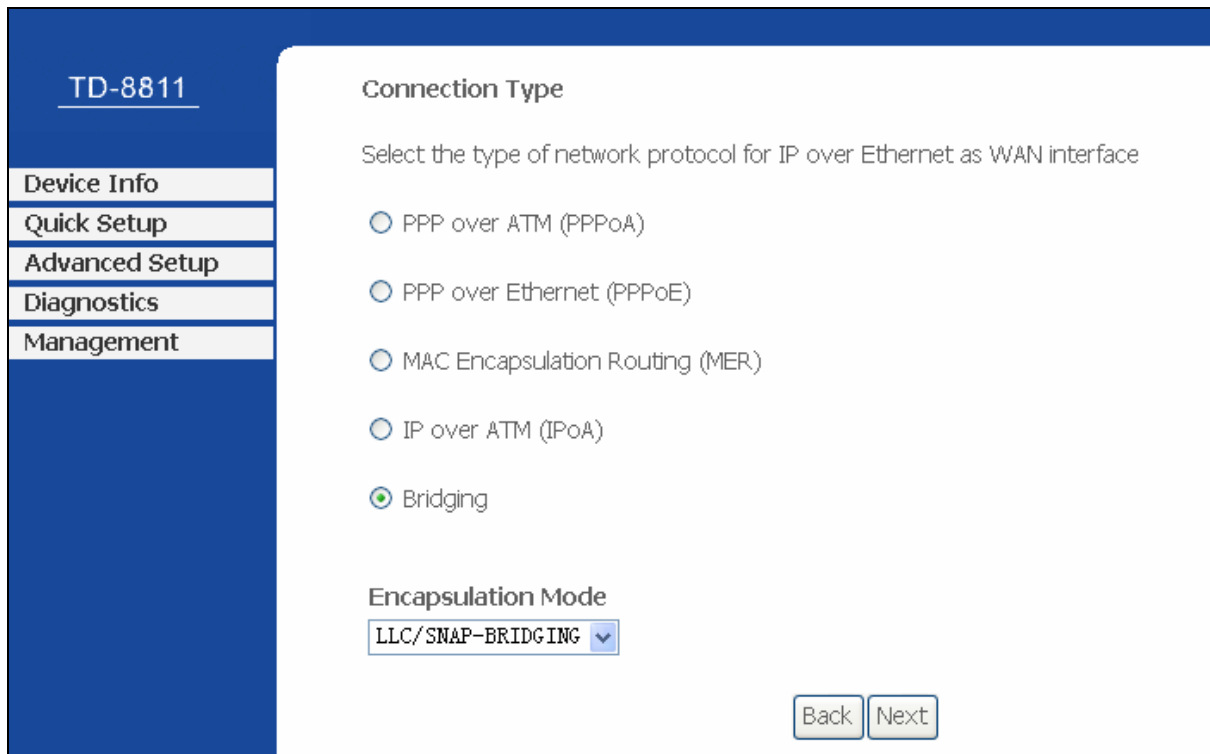

Figure 3-22

b) Click **Save/Reboot**.

WAN Setup - Summary

Make sure that the settings below match the settings provided by your ISP.

VPI / VCI:	8 / 35
Connection Type:	Bridge
Service Name:	br_8_35
Service Category:	UBR
IP Address:	Not Applicable
Service State:	Enabled
NAT:	Disabled
Firewall:	Disabled
IGMP Multicast:	Not Applicable
Quality Of Service:	Disabled

Click "Save/Reboot" to save these settings and reboot router. Click "Back" to make any modifications.

NOTE: The configuration process takes about 1 minute to complete and your DSL Router will reboot.

Figure 3-23

 **Note:**

After you complete any setup, the new setup must be saved and the Router must be restarted for the configuration to take effect. Please click the **Save/Reboot** button to restart.

3.4 Change Password

You will then see the Figure 3-24, which displays some information such as link rate and so on.

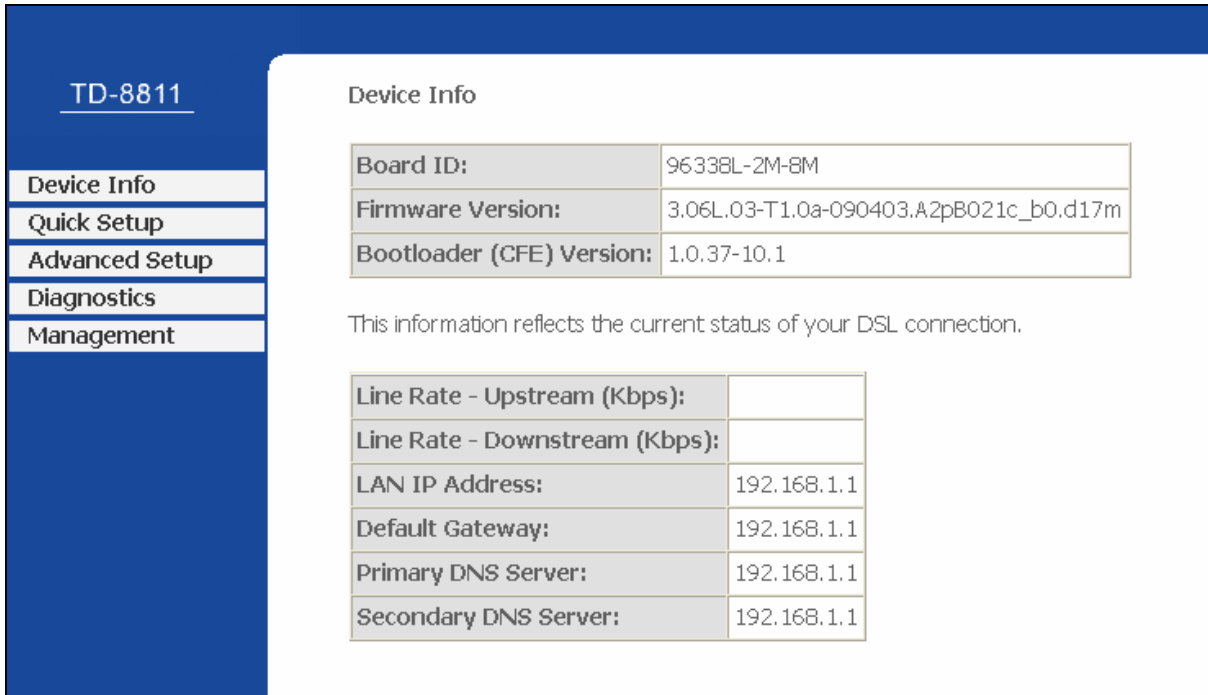

Figure 3-24

Default value of user name and password is “admin”; if you want to change them, please go to “Management” → “Access control”→“Password” changing them. (Figure 3-25)

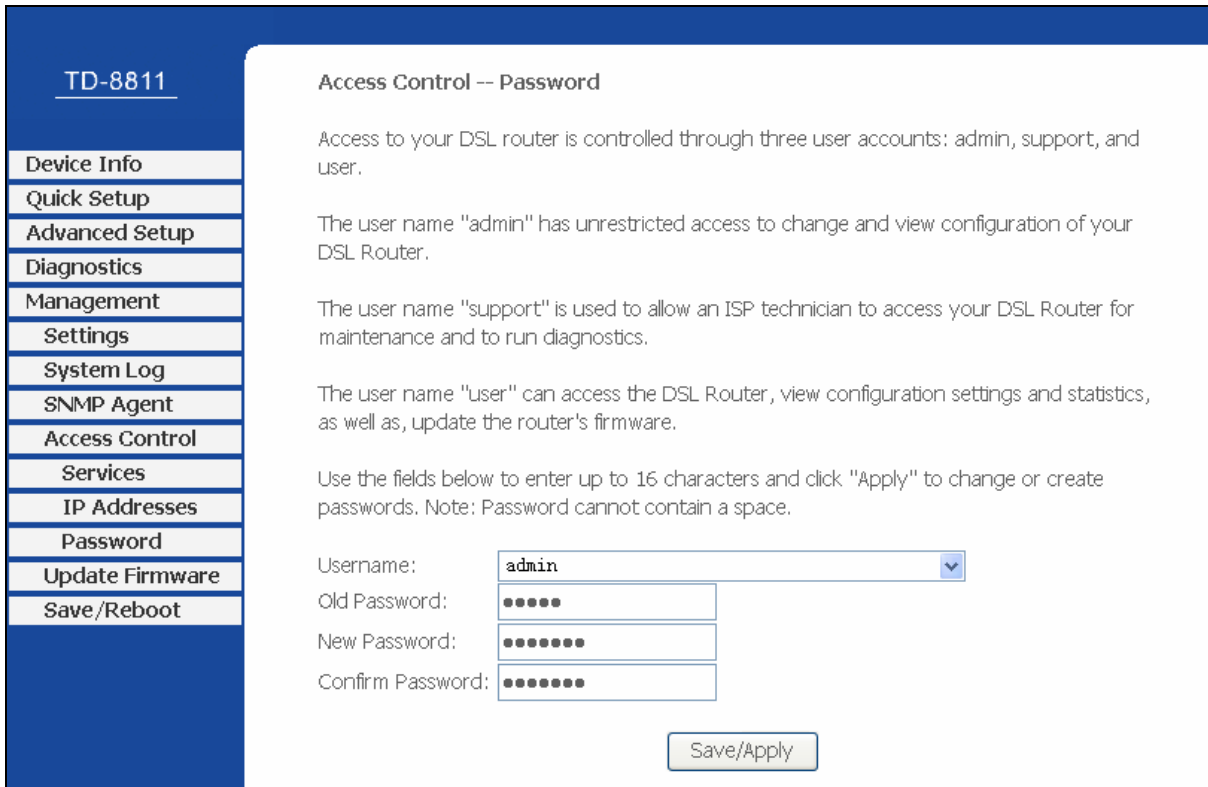

Figure 3-25

3.5 DHCP IP Reservation

When you specify a reserved IP address for a PC on the LAN, that PC will always receive the same IP address each time when it accesses the DHCP server. Reserved IP addresses should be assigned to servers that require permanent IP settings.

To setup an Address Reservation entry:

 **Note:**

1. DHCP IP Reservation is not available for the connection type of Bridge here, they won't display on the screen below since only Bridge is selected.
2. DHCP IP Reservation is not available for the connection type of PPPoE with PPP IP Extension function selected, and they won't display on the screen below since PPP IP Extension is selected.

Choose “**Advanced Setup**”→“**LAN**”, and you will see the LAN screen, the section allows you to configure the Router's LAN ports settings, and you can configure the DHCP IP Reservation function in this screen.

Local Area Network (LAN) Setup

Configure the DSL Router IP Address and Subnet Mask for LAN interface. Save button only saves the LAN configuration data. Save/Reboot button saves the LAN configuration data and reboots the router to make the new configuration effective.

IP Address:

Subnet Mask:

Disable DHCP Server

Enable DHCP Server

Start IP Address:

End IP Address:

Leased Time (hour):

Configure the second IP Address and Subnet Mask for LAN interface

Figure 3-25

1. Click the **Set Address Reservation** button, and the **Address Reservation** screen pop up,

as it showed below:

Address Reservation
 Notice:
 Your configuration won't take effect unless the ADSL router is rebooted.

ID	MAC Address	IP Address	State	Remove
0	00:11:22:33:44:AA	192.168.1.23	<input checked="" type="checkbox"/> Enable	<input type="button" value="Remove"/>

Figure 3-26

2. Click **New Entry** button to add new entries, and the screen showed below pop up, you can modify an address reservation entry in this screen;

Address Reservation Configure
 Add or Modify an Address Reservation Entry

MAC Address:
 (xx:xx:xx:xx:xx:xx)

Reserved IP Address:

State: ▼

Figure 3-27

3. Type the MAC Address (00:11:22:33:44:AA for instance) of the computer which you want to reserve an IP (192.168.1.23 for instance) for in the **MAC Address** text box;
4. Type the IP Address (192.168.1.23 for instance) you have reserved in the **Reserved IP Address** text box;
5. Click **Save** button to save the settings you have set;

Note:

The MAC Address and IP Address added in the text box used for illustrating. That may be different to your circs.

6. When you have saved the settings, the new entry will added to the **Address Reservation** screen showed below.

Address Reservation

Notice:
Your configuration won't take effect unless the ADSL router is rebooted.

ID	MAC Address	IP Address	State	Remove
0	00:11:22:33:44:AA	192.168.1.23	<input checked="" type="checkbox"/> Enable	<input type="button" value="Remove"/>

Figure 3-28

7. Click **Save/Reboot** button to save the settings and reboot the router.

Note:

The function won't take effect until the router reboots.

3.6 USB Configuration

If you use the USB interface, firstly, you must install the USB driver to the computer. You can obtain the drives from the provided CD or download from our website. (<http://www.tp-link.com>)

USB Drive installation procedures

If the hardware is installed before the computer is Power On. Please turn on the computer and enter the operating system, Then the operating system will identify the device. If the hardware is installed after the computer is Power On, the desktop will display the information about finding the new hardware.

- 1) You will see the Figure 3-26 requiring install software for USB Device, select "Install from a list or specific location (Advanced)" and click **Next** to continue.



Figure 3-26

- 2) After that, the Figure 3-27 will display. Select the “search removable media(floppy, CD-ROM…)” and click **Next**.

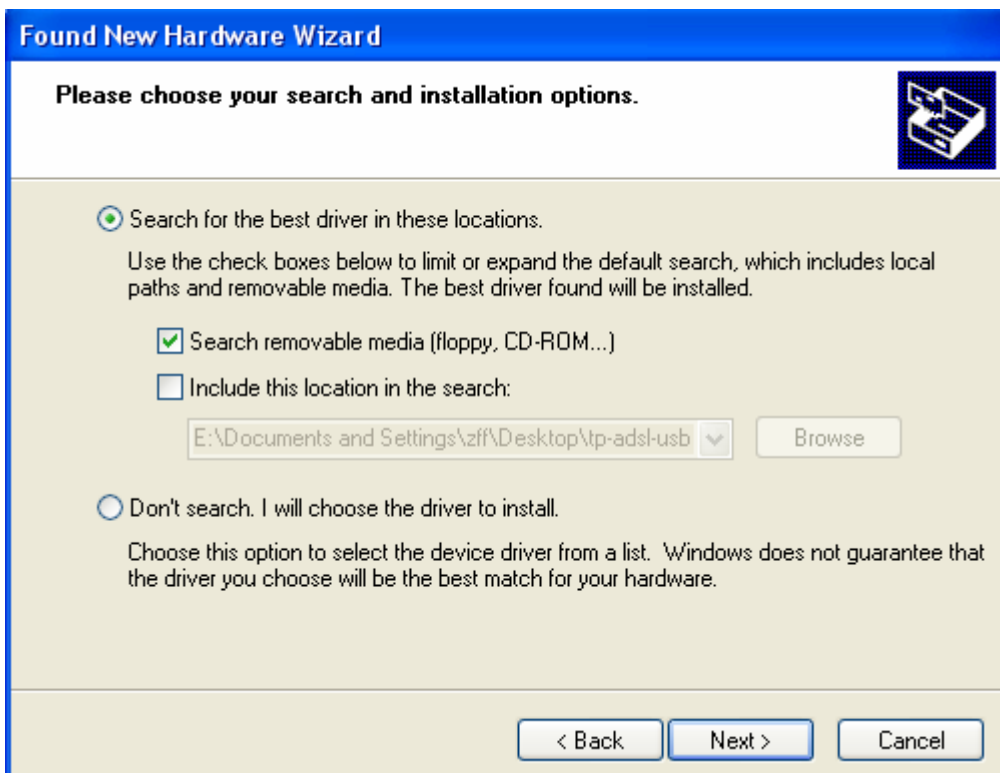

Figure 3-27

3) Then Figure 3-28 is available. The driver will be searched and installed.

 **Note:**

You must insert the CD first.

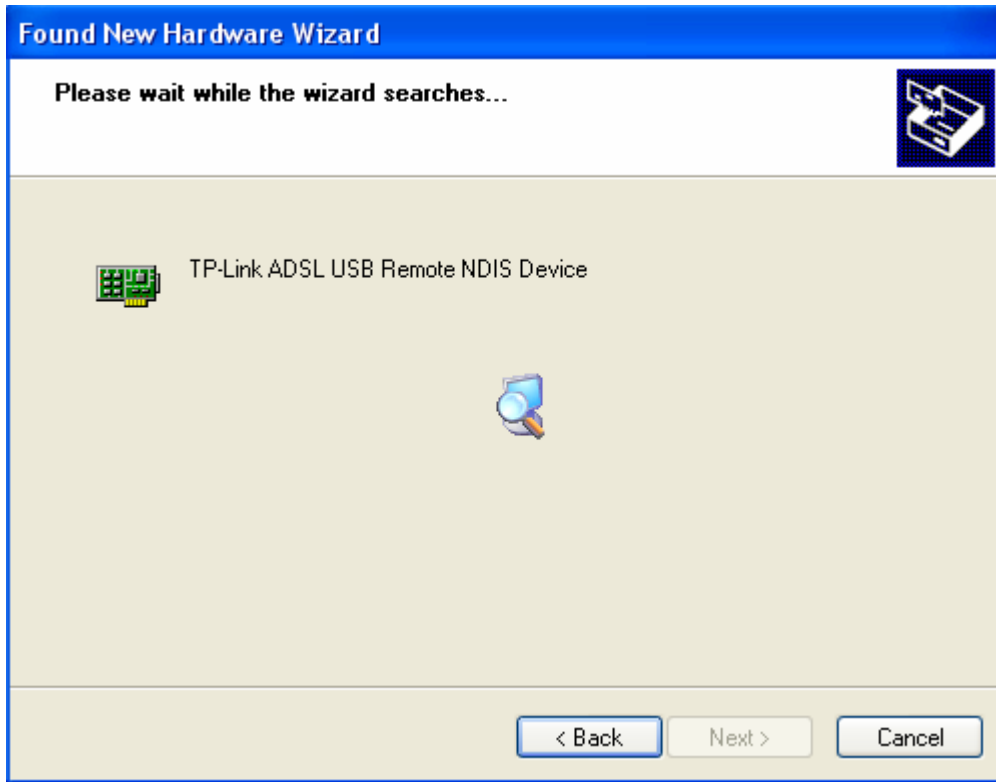

Figure 3-28

4) After that, you will see the Figure 3-29. Click **Finish** to complete the installation.



Figure 3-29

Please refer to [chapter 3.1](#) to finish the IP configuration for USB connect. Then you could use the USB device.

 **Note:**

- 1) All of the above settings are under windows XP.
- 2) If you want to pull out the USB device you must disconnect the network of USB first.

Chapter 4. Web-based Configuration

4.1 Device Info

The Device Info page provides the current information about the ADSL2+ Modem Router. All information is read-only.

The screenshot shows the TP-LINK TD-8811 web interface. On the left is a blue sidebar menu with the following items: **Device Info** (highlighted in red), Summary, WAN, Statistics, Route, ARP, DHCP, Quick Setup, Advanced Setup, Diagnostics, and Management. The main content area is white and titled "Device Info". It contains a table with the following data:

Board ID:	96338L-2M-8M
Firmware Version:	3.06L.03-T1.0a-090403.A2pB021c_b0.d17m
Bootloader (CFE) Version:	1.0.37-10.1

Below the table is a note: "This information reflects the current status of your DSL connection." Underneath is another table with network settings:

Line Rate - Upstream (Kbps):	
Line Rate - Downstream (Kbps):	
LAN IP Address:	192.168.1.1
Default Gateway:	192.168.1.1
Primary DNS Server:	192.168.1.1
Secondary DNS Server:	192.168.1.1

Figure 4-1

The information about the **Summary**, **WAN**, **Statistics**, **Route**, **ARP**, and **DHCP** are all displayed. Click each of them, and you can get the detailed information.

4.2 Quick Setup

Please refer to [3.3 Quick Setup](#).

4.3 Advanced Setup

Choose "**Advanced Setup**", and you can see the submenus as shown in Figure 4-2.

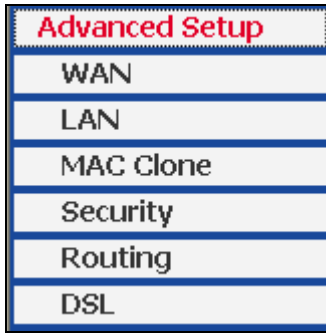

Figure 4-2

4.3.1 WAN

Choose “**Advanced Setup**”→”**WAN**”, and you will see the page of Wide Area Network (WAN) Setup as shown in Figure 4-3.

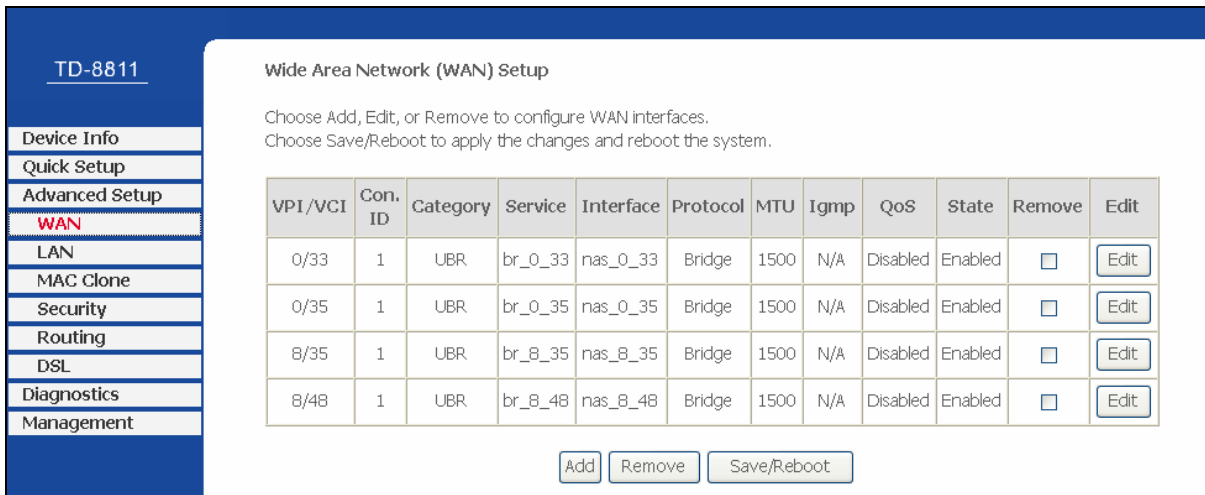

Figure 4-3

There are 4 PVC links in the **WAN** setup page. Click the **Add** button or choose the appropriate PVC according to your need. Then you will enter the page of **ATM PVC Configuration** as shown in Figure 4-4.

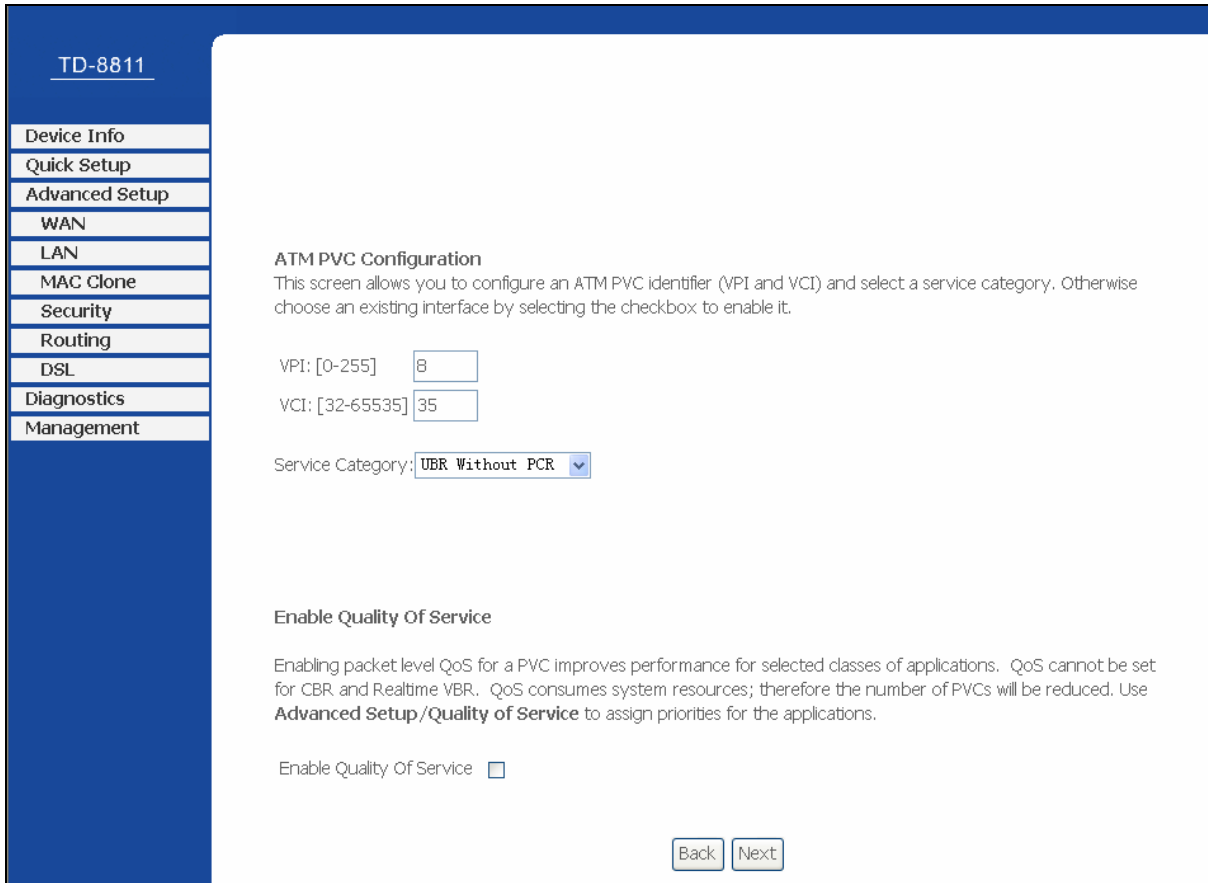

Figure 4-4

Enter **VPI/VCI** value and service category provided by your ISP. Click **Next** to enter the next step. You will see the Figure 4-5.

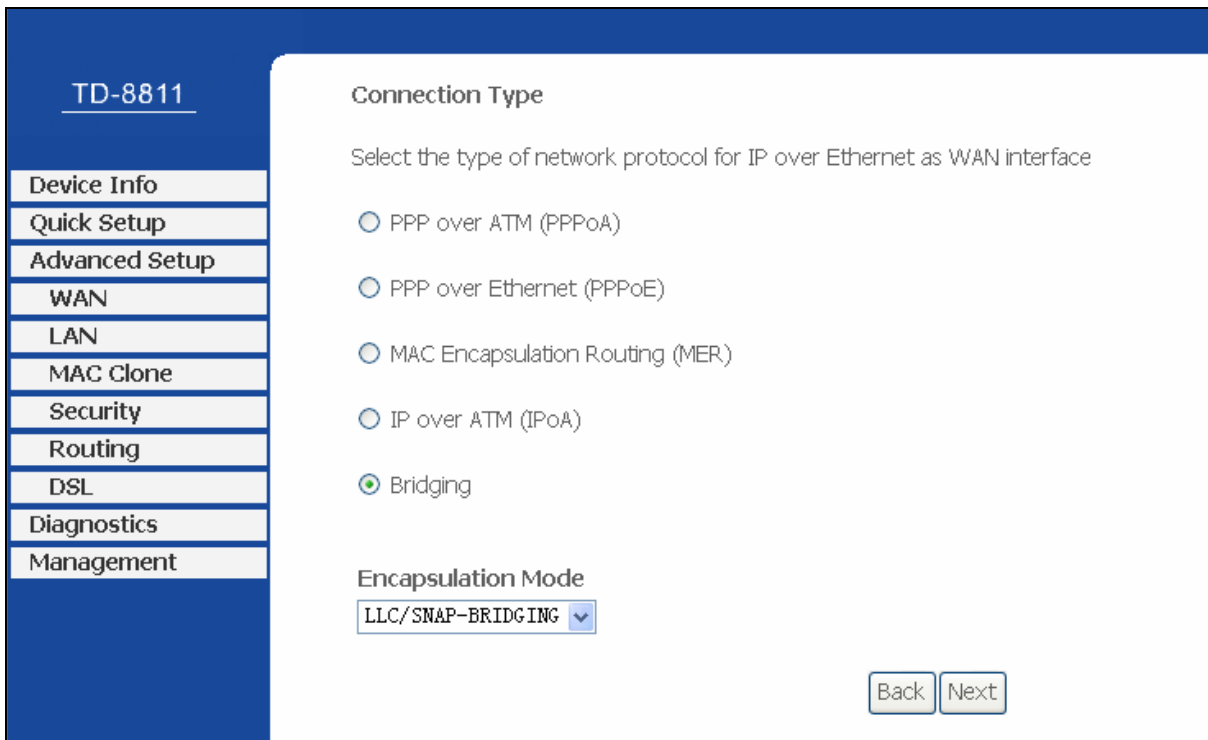

Figure 4-5

After choosing the proper protocol, enter the correct parameters supported by your ISP. Enable the configurations, and then you will go to the Internet.

 **Note:**

The type of network protocol selected may be different in different areas. There are five types (Figure 4-5), so you should ask your ISP to acquire the **Connection Type** and **Encapsulation Mode**.

➤ **PPP over ATM (PPPoA)**

If you select the protocol of PPP over ATM (PPPoA), you will see the Figure 4-6.

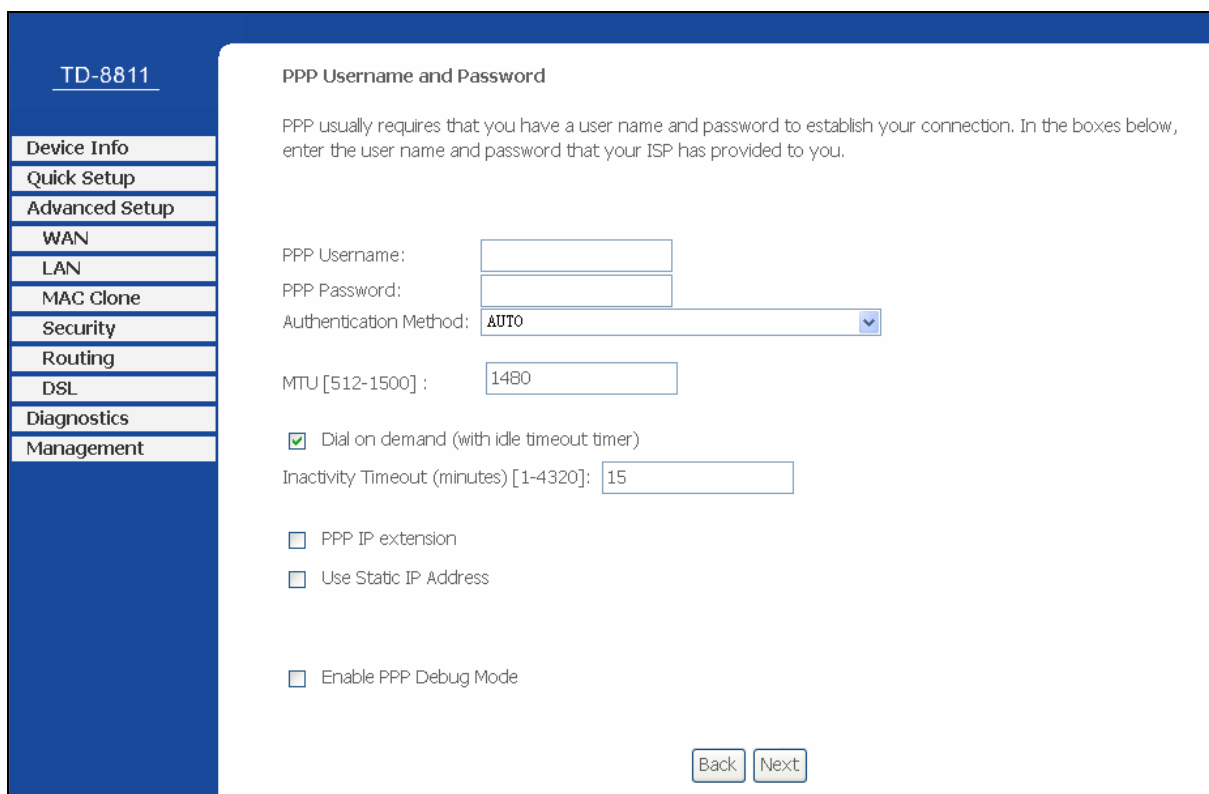

The screenshot shows the 'PPP Username and Password' configuration page in the TD-8811 web interface. The left sidebar contains a navigation menu with options: Device Info, Quick Setup, Advanced Setup, WAN, LAN, MAC Clone, Security, Routing, DSL, Diagnostics, and Management. The main content area is titled 'PPP Username and Password' and includes the following text: 'PPP usually requires that you have a user name and password to establish your connection. In the boxes below, enter the user name and password that your ISP has provided to you.'

The configuration fields are:

- PPP Username: [Text input field]
- PPP Password: [Text input field]
- Authentication Method: [Dropdown menu showing 'AUTO']
- MTU [512-1500]: [Text input field showing '1480']
- Dial on demand (with idle timeout timer)
- Inactivity Timeout (minutes) [1-4320]: [Text input field showing '15']
- PPP IP extension
- Use Static IP Address
- Enable PPP Debug Mode

At the bottom right, there are 'Back' and 'Next' buttons.

Figure 4-6

- **PPP Username:** Enter your username for your PPPoA connection to identify and verify your account to the ISP.
- **PPP Password:** Enter your password for your PPPoA connection.
- **Authentication Method:** Choose a method of authentication, **AUTO**, **PAP**, **CHAP**, or **MSCHAP**.
- **MTU:** The default **MTU** value is 1480 Bytes. It is not recommended that you change the default value unless required by your ISP. The value should be between 512 and 1500.
- **Dial on demand:** If you check this box, the Internet connection can be terminated automatically after a specified inactivity period (**Inactivity Timeout**) and be re-established when you attempt to access the Internet again. The default value of **Inactivity Timeout** is 15. The value should be between 1 and 4320.

- **PPP IP extension:** If this box is checked, the IP address obtained by the Router will be assigned to the computer, and the NAT and Firewall will be disabled.
- **Use Static IP Address:** Check this box to use the static IP address to dial. The default value is disabled.
- **Enable PPP Debug Mode:** Check this box to enable the debug mode. The default value is disabled.

Click **Next** button in Figure 4-6, and then you will see Figure 4-7. Check or uncheck the **Enable WAN Service** box according to your needs.

TD-8811

Device Info

Quick Setup

Advanced Setup

WAN

LAN

MAC Clone

Security

Routing

DSL

Diagnostics

Management

Enable WAN Service

Enable WAN Service

Service Name

Back Next

Figure 4-7

Click the **Next** button to enter the next step as shown in Figure 4-8. Click **Save** to complete the configuration.

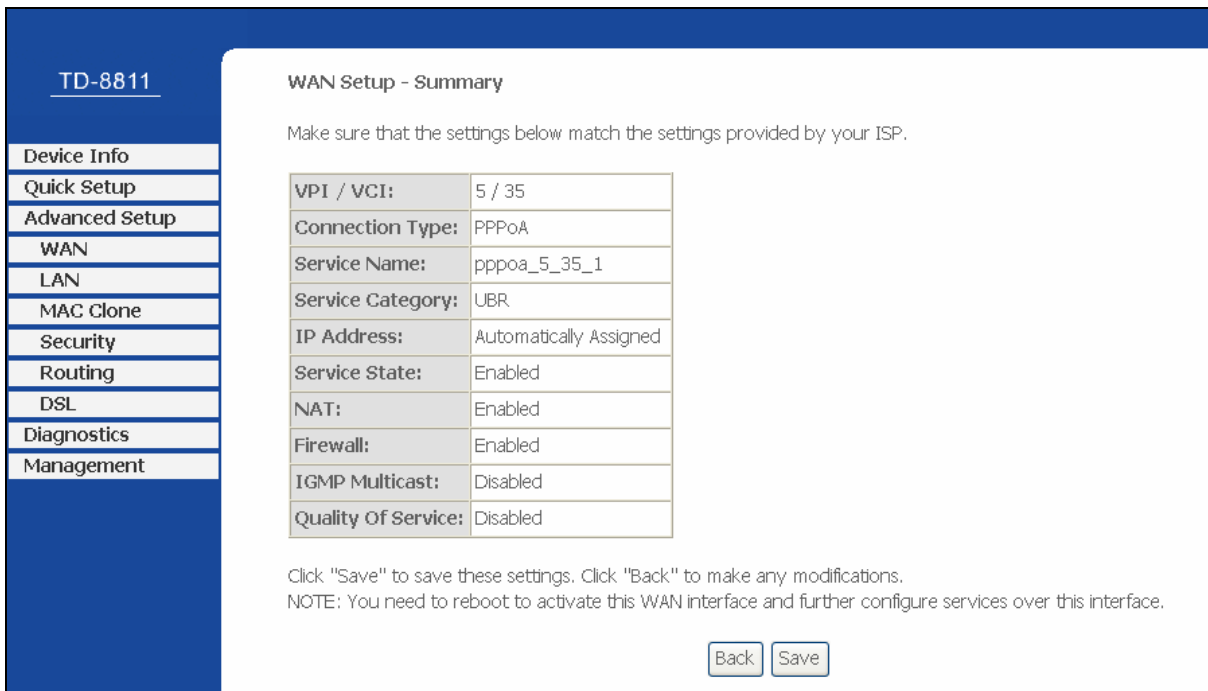

Figure 4-8

➤ **PPP over Ethernet (PPPoE)**

If you select the protocol of PPP over Ethernet (PPPoE), you will see the Figure 4-9.

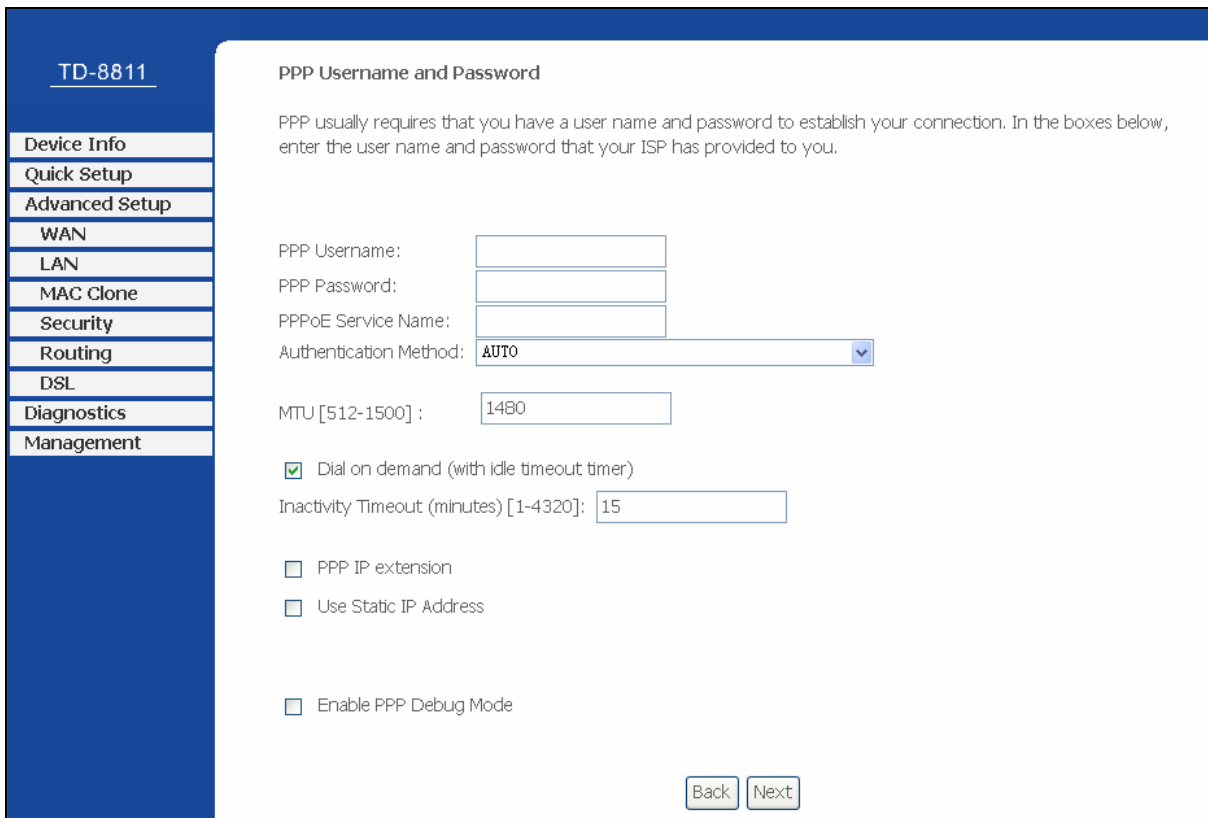
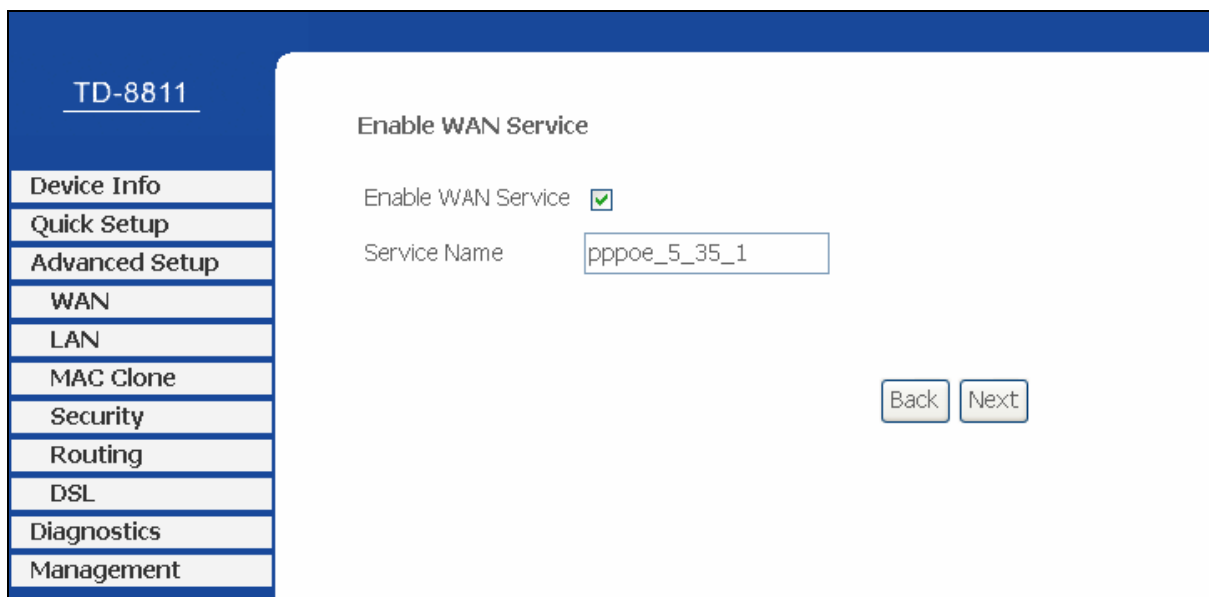

Figure 4-9

- **PPP Username:** Enter your username for your PPPoE connection to identify and verify your account to the ISP.

- **PPP Password:** Enter your password for your PPPoE connection.
- **PPPoE Service Name:** Enter a name for the PPPoE connection for recognition.
- **Authentication Method:** Choose a method of authentication, **AUTO**, **PAP**, **CHAP**, or **MSCHAP**.
- **MTU:** The default **MTU** value is 1480 Bytes. It is not recommended that you change the default value unless required by your ISP. The value should be between 512 and 1500.
- **Dial on demand:** If you check this box, the Internet connection can be terminated automatically after a specified inactivity period (**Inactivity Timeout**) and be re-established when you attempt to access the Internet again. The default value of **Inactivity Timeout** is 15. The value should be between 1 and 4320.
- **PPP IP extension:** If this box is checked, the IP address obtained by the Router will be assigned to the computer, and the NAT and Firewall will be disabled.
- **Use Static IP Address:** Check this box to use the static IP address to dial. The default value is disabled.
- **Enable PPP Debug Mode:** Check this box to enable the debug mode. The default value is disabled.

Click **Next** button in Figure 4-9, and then you will Figure 4-10. Check or uncheck the **Enable WAN Service** box according to your needs.



The screenshot shows the configuration interface for the TD-8811 router. On the left is a navigation menu with the following items: Device Info, Quick Setup, Advanced Setup, WAN, LAN, MAC Clone, Security, Routing, DSL, Diagnostics, and Management. The 'WAN' item is currently selected. The main content area is titled 'Enable WAN Service'. It contains two settings: 'Enable WAN Service' with a checked checkbox, and 'Service Name' with a text input field containing 'pppoe_5_35_1'. At the bottom right of the main area are two buttons: 'Back' and 'Next'.

Figure 4-10

Click the **Next** button to enter the next step as shown in Figure 4-11. Click **Save** to complete the configuration.

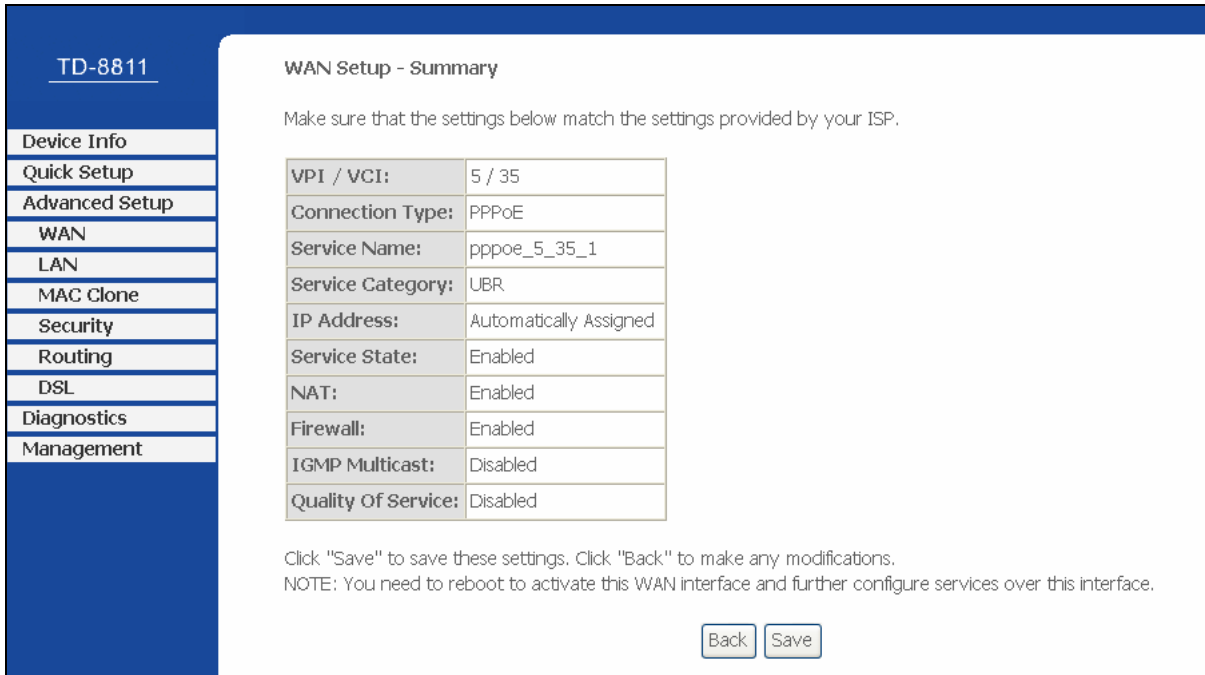

Figure 4-11

➤ **MAC Encapsulation Routing (MER)**

If you select the protocol of MAC Encapsulation Routing (MER), you will see the page as shown in Figure 4-12.

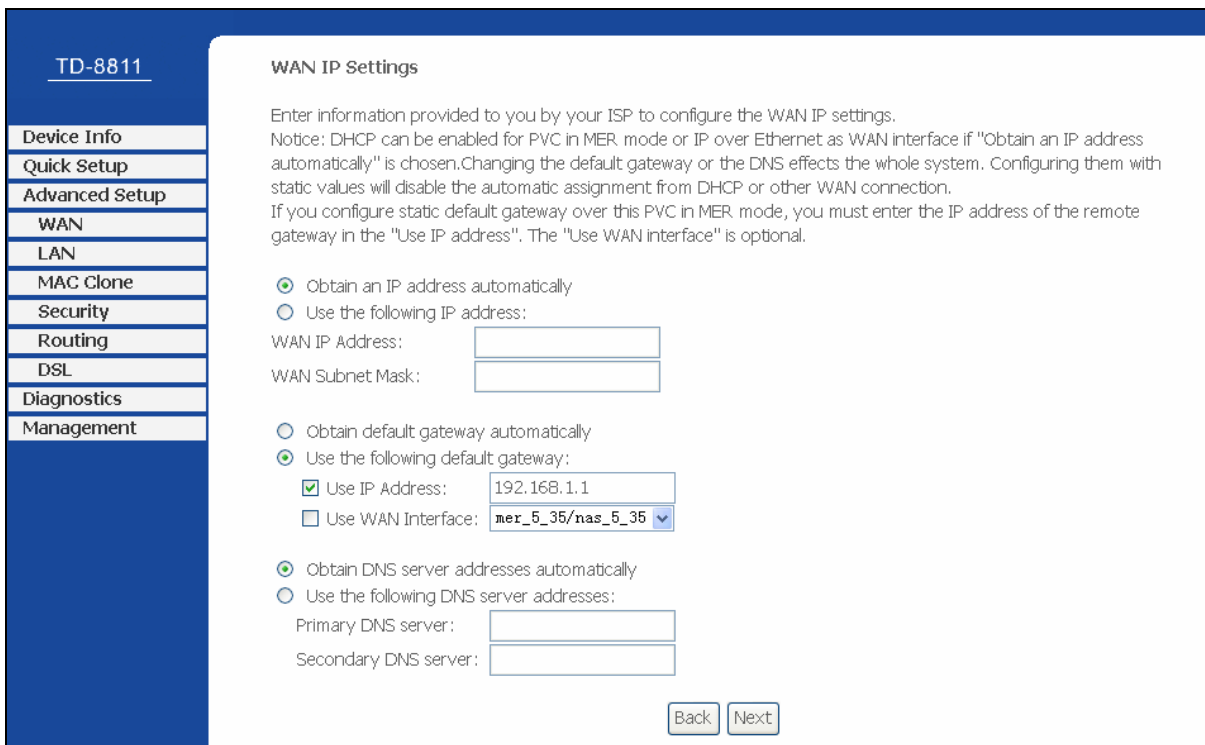

Figure 4-12

- **Obtain an IP address automatically:** Check this radio button to obtain the IP address automatically. This is not recommended by default.
- **Use the following IP address:** This radio button is checked by default. Enter the

information provided by your ISP to configure the WAN IP settings.

- **Obtain default gateway automatically:** This radio button is checked by default. It's recommended that you keep the default settings to allow the Router to obtain the default gateway automatically.
- **Use the following default gateway:** Check this radio button then you can enter the IP address and the WAN interface for the default gateway. This is not recommended by default.
- **Obtain DNS server addresses automatically:** This radio button is checked by default. It's recommended that you keep the default settings to allow the Router to obtain the default DNS server addresses automatically.
- **Use the following DNS server addresses:** Check this radio button then you can enter the primary DNS server and secondary DNS server. This is not recommended by default.

 **Note:**

- ◆ DHCP can be enabled for PVC in MER mode as WAN interface if "Obtain an IP address automatically" is chosen.
- ◆ Changing the default gateway or the DNS will affect the whole system. Configuring them with static values will disable the automatic assignment from DHCP or other WAN connection.
- ◆ If you configure static default gateway over this PVC in MER mode, you must enter the IP address of the remote gateway in the "Use IP address". The "Use WAN interface" is optional.

Click **Next** button in Figure 4-12, and then you will see the Figure 4-13. Check or uncheck the **Enable WAN Service** box according to your needs.

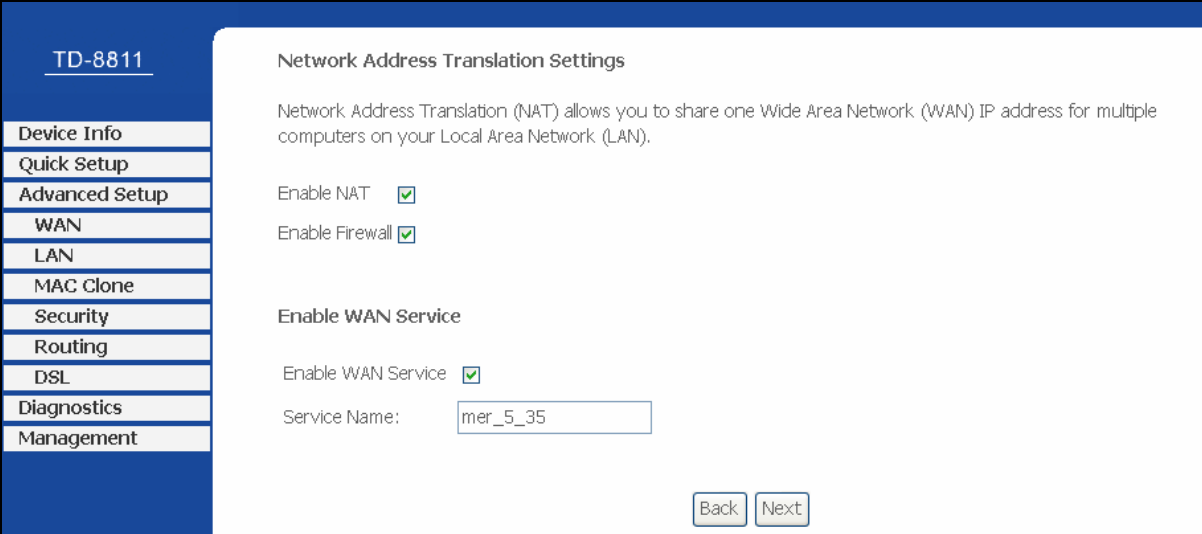

TD-8811

Device Info

Quick Setup

Advanced Setup

WAN

LAN

MAC Clone

Security

Routing

DSL

Diagnostics

Management

Network Address Translation Settings

Network Address Translation (NAT) allows you to share one Wide Area Network (WAN) IP address for multiple computers on your Local Area Network (LAN).

Enable NAT

Enable Firewall

Enable WAN Service

Enable WAN Service

Service Name:

Back Next

Figure 4-13

Click the **Next** button to enter the next step as shown in Figure 4-14. Click **Save** to complete the configuration.

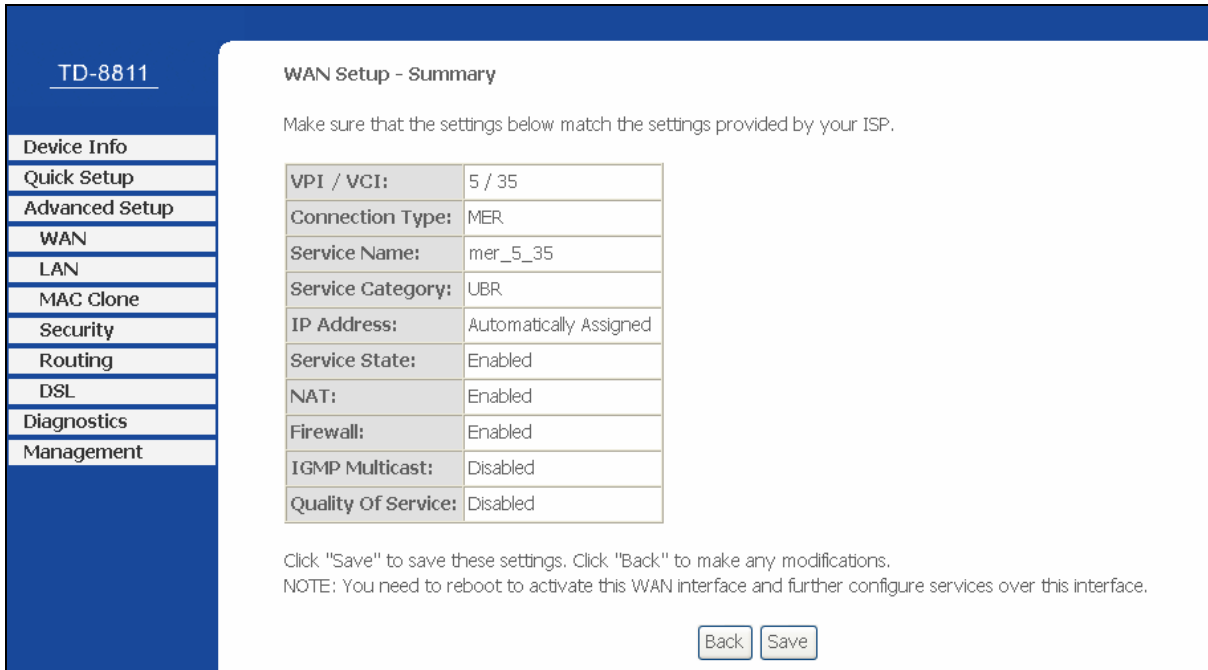

Figure 4-14

➤ **IP over ATM (IPoA)**

If you select the protocol of IP over ATM (IPoA), you will see the Figure 4-15. Enter the parameters provided by your ISP.

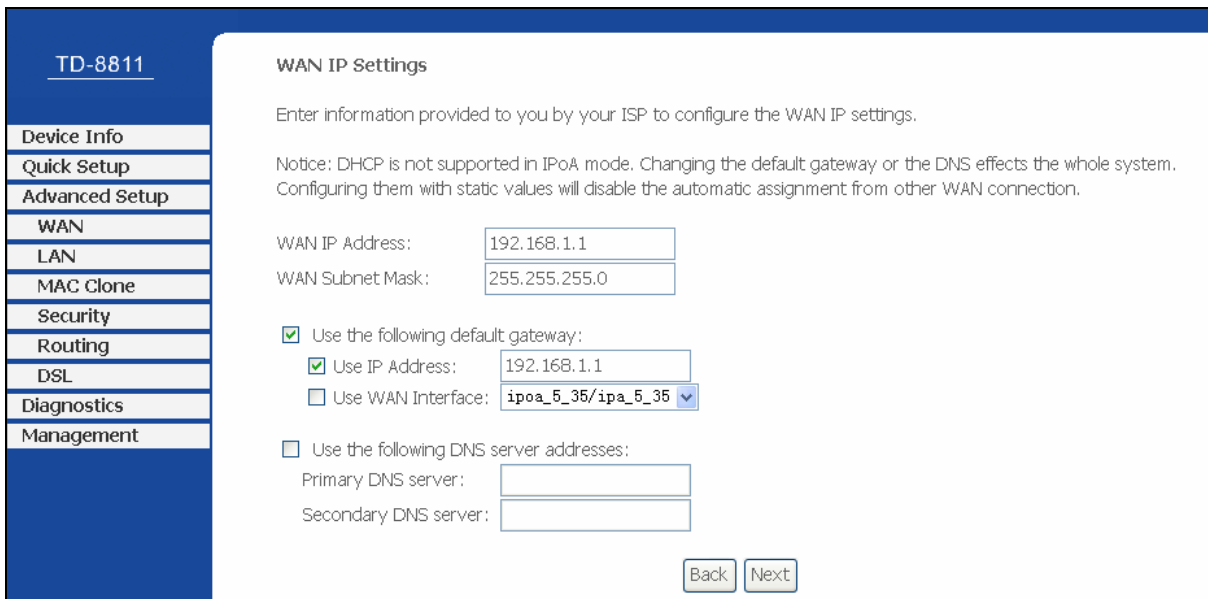

Figure 4-15

- **WAN IP Address:** Enter the IP Address provided by your ISP.
- **WAN Subnet Mask:** Enter the subnet mask provide by your ISP.
- **Use the following default gateway:** Check this radio button then you can choose **Use IP Address** or **Use WAN Interface**. If you have any problems, please ask your ISP for the information.

- **Use the following DNS server addresses:** Check this radio button then you can enter the primary DNS server and secondary DNS server. If you have any problems, please ask your ISP for the information.

 **Note:**

- ◆ DHCP is not supported in IPoA mode.
- ◆ Changing the default gateway or the DNS will affect the whole system. Configuring them with static values will disable the automatic assignment from other WAN connection.

Click **Next** in Figure 4-15, and then you will see the Figure 4-16.

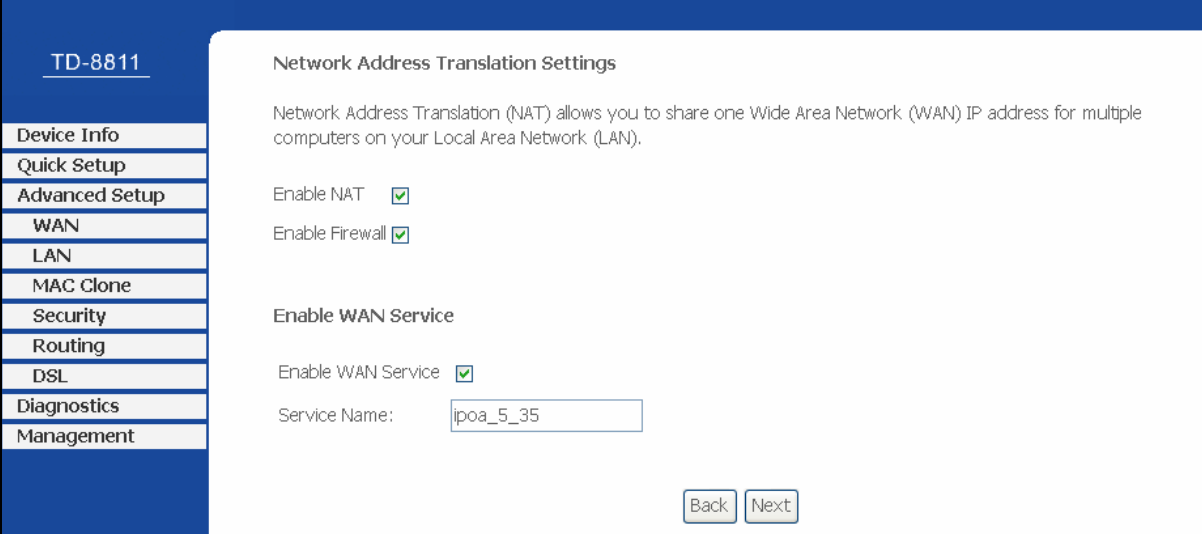

The screenshot shows the 'Network Address Translation Settings' page. On the left is a navigation menu with 'TD-8811' at the top and various settings categories below. The main content area has a title 'Network Address Translation Settings' and a descriptive paragraph about NAT. Below this are three checked checkboxes: 'Enable NAT', 'Enable Firewall', and 'Enable WAN Service'. Under 'Enable WAN Service', there is a 'Service Name' field containing the text 'ipoa_5_35'. At the bottom right of the main content area are 'Back' and 'Next' buttons.

Figure 4-16

Check or uncheck the **Enable WAN Service** box according to your needs. Click the **Next** button to enter the next step as shown in Figure 4-17, and click **Save** to complete the configuration.

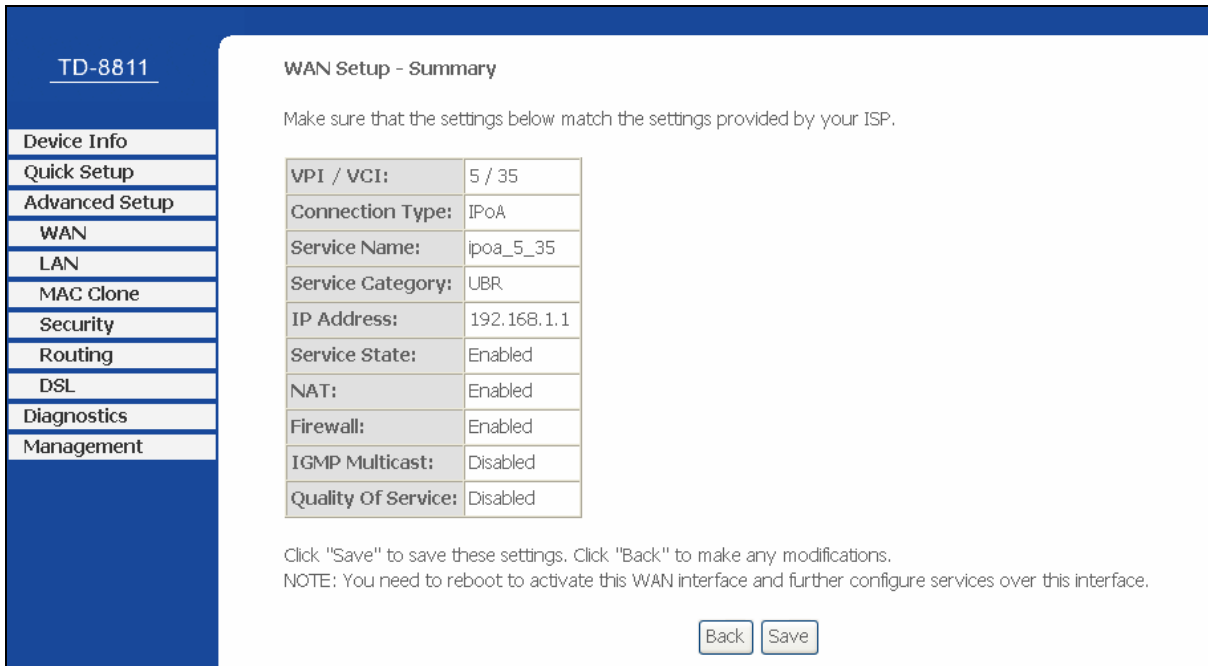

Figure 4-17

➤ **Bridging**

If you select the Bridging protocol, you will see the Figure 4-18. Click the **Next** button.

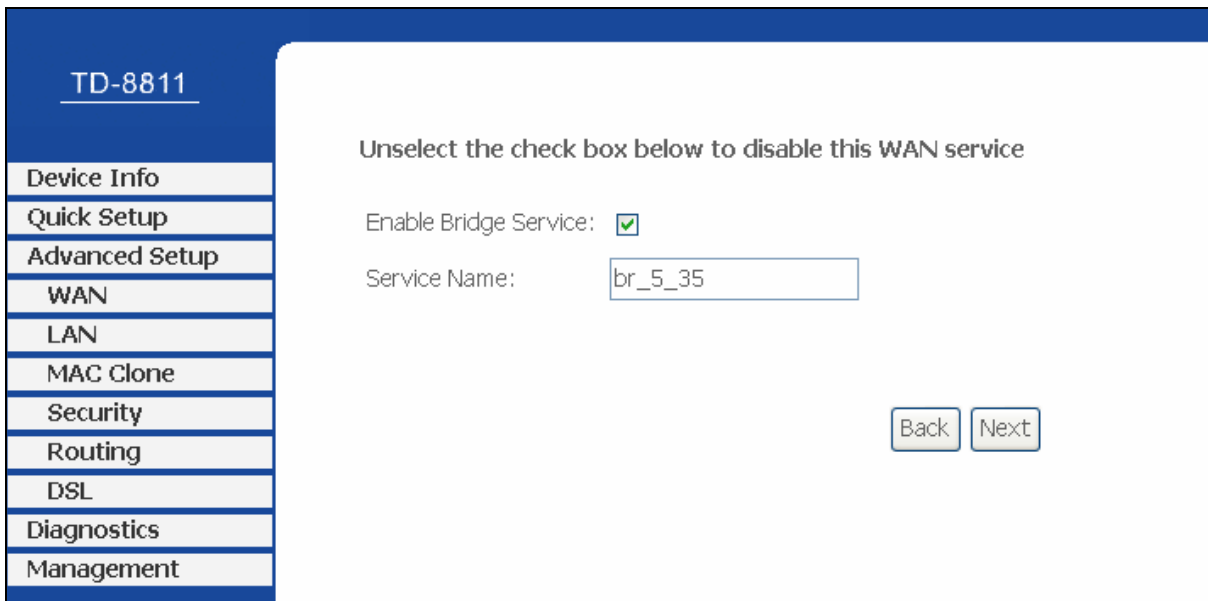

Figure 4-18

Then you will see the Figure 4-19. Click **Save** to complete the configuration

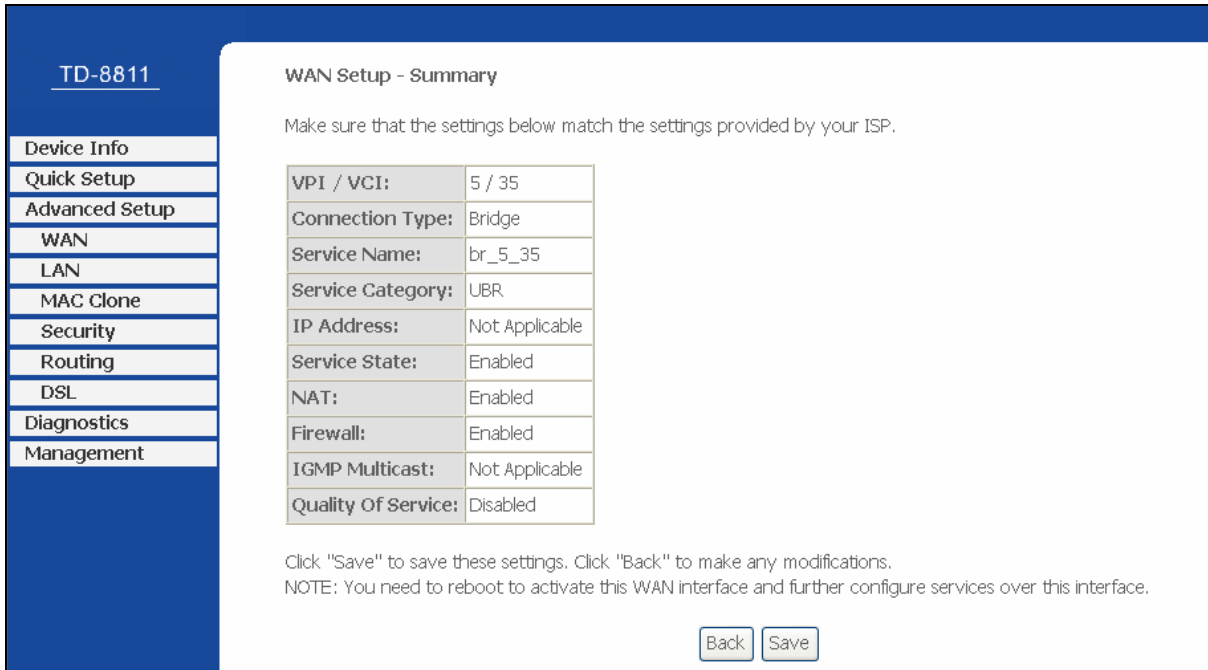

Figure 4-19

Note:

After completing any setup, the new setup must be saved and the Router must be restarted for the configuration to go into effect. Please click the **Save/Reboot** button to restart as shown in Figure 4-20.

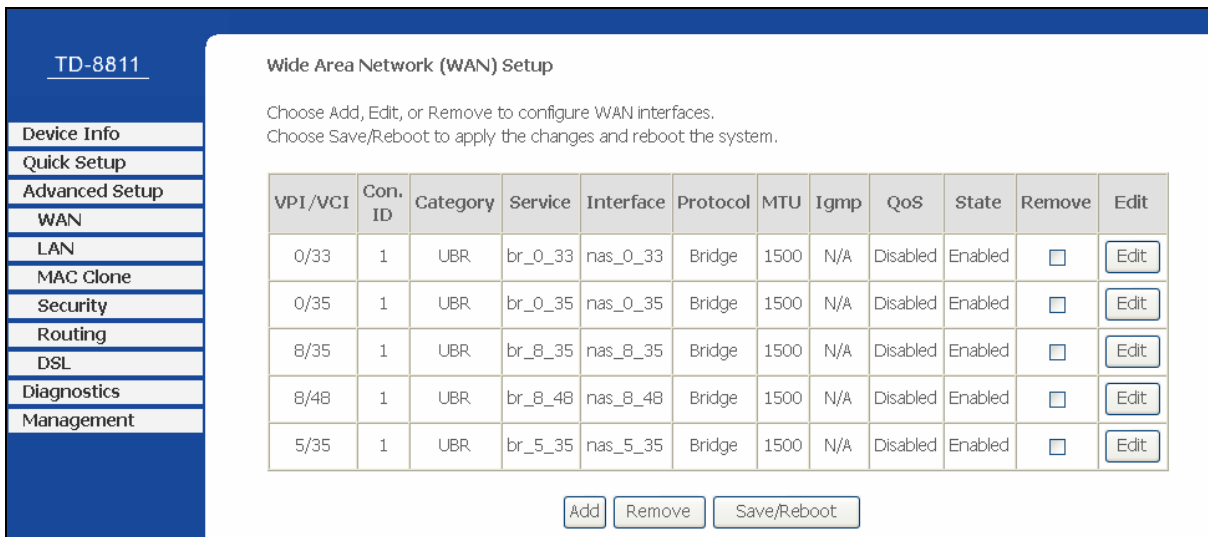

Figure 4-20

Note:

All of the above setup is under windows XP OS.

4.3.2 LAN

Choose “**Advanced Setup→LAN**” menu, and you can see and configure the Local Area

Network (LAN) parameters in the screen as shown in Figure 4-21.

TD-8811

Local Area Network (LAN) Setup

Configure the DSL Router IP Address and Subnet Mask for LAN interface. Save button only saves the LAN configuration data. Save/Reboot button saves the LAN configuration data and reboots the router to make the new configuration effective.

IP Address:

Subnet Mask:

Disable DHCP Server

Enable DHCP Server

Start IP Address:

End IP Address:

Leased Time (hour):

Configure the second IP Address and Subnet Mask for LAN interface

Figure 4-21

- **IP Address** - Enter an IP address for the Router. Then you can access the Web-based Utility via this IP address. The default setting is 192.168.1.1.
 - **Subnet Mask** - An address code that determines the size of the network. Normally use 255.255.255.0 as the subnet mask.
- Note:**
- a. If you change the IP Address of LAN, you must use the new IP Address to log in the Router.
 - b. If the new LAN IP Address you set is not in the same subnet, the IP Address pool of the DHCP server will change accordingly at the same time, while the Virtual Server and DMZ Host will not take effect until they are re-configured.
- **Disable/Enable DHCP Server** - **Disable** or **Enable** the DHCP server. DHCP stands for Dynamic Host Configuration Protocol. The DHCP Server will automatically assign dynamic IP addresses to the computers on the network. If you disable the Server, you must have another DHCP server within your network or else you must configure the computer manually. The following options are available only when DHCP Server is enabled.
 - **Start IP Address** - Specify an IP address for the DHCP Server to start with when assigning IP addresses. 192.168.1.100 is the default start address
 - **End IP Address** - Specify an IP address for the DHCP Server to end with when assigning IP addresses. 192.168.1.199 is the default end address.
 - **Leased Time (hour)** - The **Lease Time** is the amount of time a network user will be allowed connection to the Router with their current dynamic IP address. Enter the amount of time, in hours, and the user will be "leased" this dynamic IP address. After the time is up, the user will be automatically assigned a new dynamic IP address. The

default value is 24 hours.

- **Set Address Reservation** - Click this button, you can view and add a reserved address for clients via the **Address Reservation** page as shown in Figure 4-21. When you specify a reserved IP address for a PC on the LAN, that PC will always receive the same IP address each time when it accesses the DHCP server. Reserved IP addresses should be assigned to servers that require permanent IP settings.
- **Configure the second IP Address and Subnet Mask for LAN interface** - Check this box, and you can configure a second IP address and subnet mask for the LAN interface.
- **Save** - Clicking this button only saves the LAN configuration data.
- **Save/Reboot** - Clicking this button not only saves the LAN configuration data but also reboots the Router to make the new configuration take effect.

To Reserve an IP address:

1. Click the **Set Address Reservation** button shown in Figure 4-21 to enter the screen as shown in Figure 4-22.

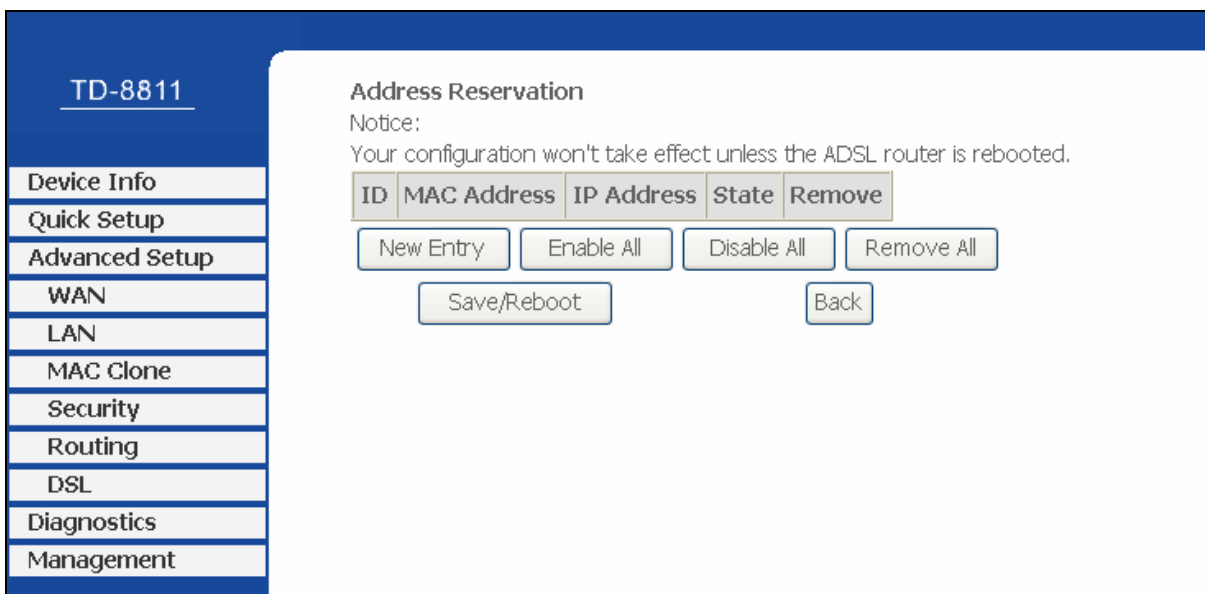

Figure 4-22

2. Click the **New Entry** button in Figure 4-22. Then Figure 4-23 will pop up.

Figure 4-23

3. Enter the MAC address in XX:XX:XX:XX:XX:XX format and reserved IP address in dotted-decimal notation of the computer for which you want to reserve an IP address.

Note:

The MAC Address and IP Address added in Figure 4-23 are used for illustrating. They may be different to your circs.

4. Select **Enable** from the **State** drop-down list.
5. Click the **Save** button, then you will go back to the **Address Reservation** screen and see the new entry as shown in Figure 4-22.
6. Click **Save/Reboot** button to save the settings and reboot the Router.

Note:

The function won't take effect until the router reboots.

4.3.3 MAC Clone

Choose “**Advanced Setup**→**MAC Clone**” menu, you can configure the MAC address of the WAN on the screen as shown in Figure 4-24.

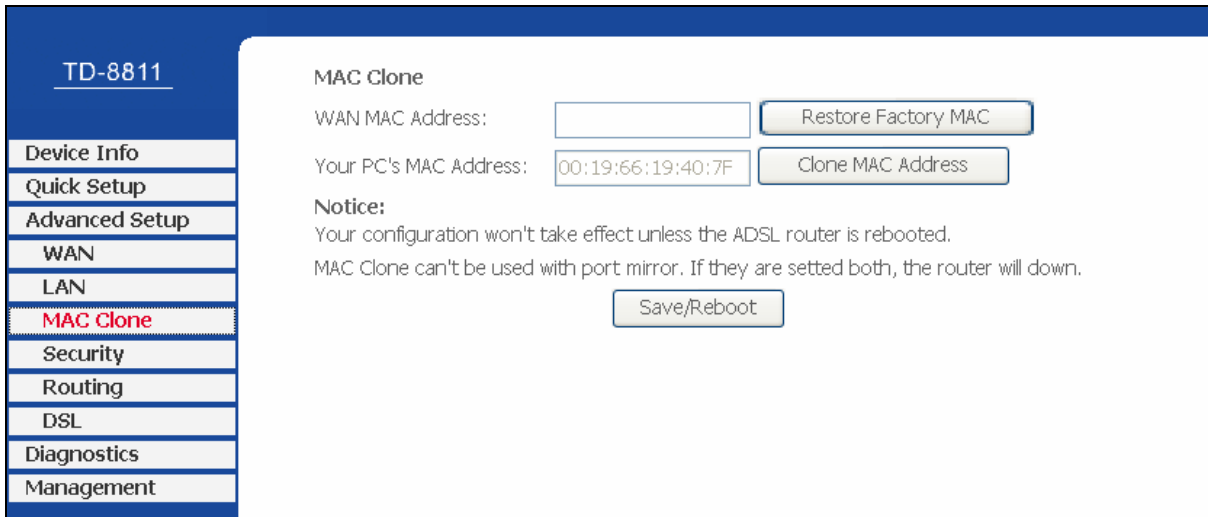

Figure 4-24

Some ISPs require that you register the MAC Address of your adapter. Changes are rarely needed here.

- **WAN MAC Address** - This field displays the current MAC address of the WAN port. If your ISP requires you to register the MAC address, please enter the correct MAC address into this field in XX:XX:XX:XX:XX:XX format (X is any hexadecimal digit).
- **Your PC's MAC Address** - This field displays the MAC address of the PC that is managing the Router. If the MAC address is required, you can click the **Clone MAC Address** button and this MAC address will be filled in the **WAN MAC Address** field.

Click **Restore Factory MAC** to restore the MAC address of WAN port to the factory default value.

Click the **Save/Reboot** button to save your settings.

Note:

1. Only the PC on your LAN can use the **MAC Address Clone** function.
2. Your configuration won't take effect unless the ADSL Router is rebooted.
3. MAC Clone can't be used with port mirror. If they are set both, the Router will be down.

4.3.4 Security

Choose "**Advanced Setup**→**Security**" menu, you can do some security configurations for your Router. There are two submenus under the Security menu as shown in Figure 4-25.



Figure 4-25

4.3.4.1 MAC Filtering

Choose “**Security**→**MAC Filtering**” menu, you can configure the MAC filtering rule in the next screen similar to Figure 4-26. The MAC Address Filtering feature allows you to control the access of users on your local network basing on their MAC addresses.

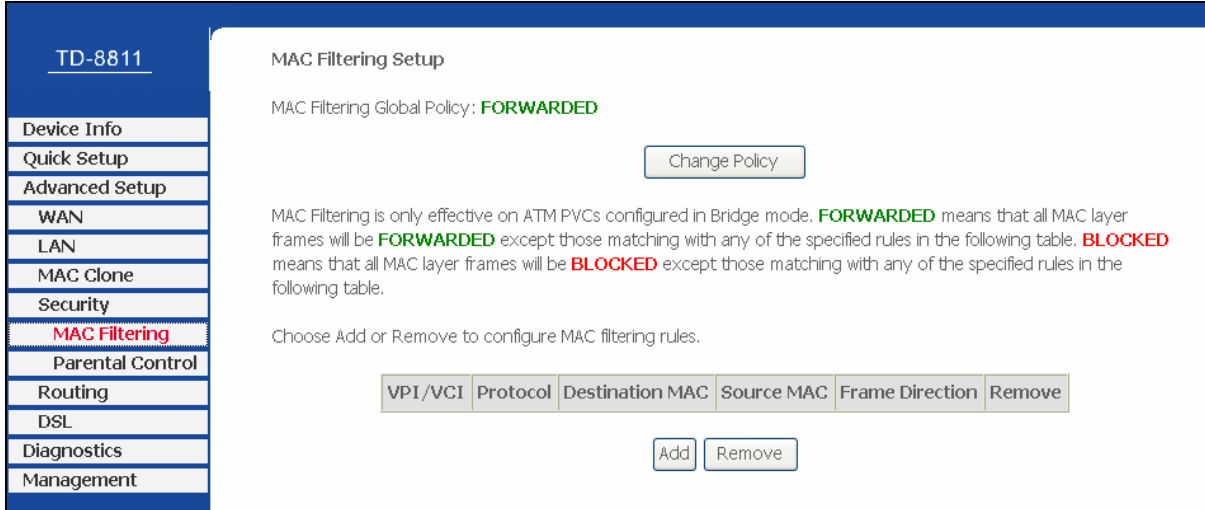

Figure 4-26

MAC Filtering Global Policy - The default setting is FORWARDED.

- **FORWARDED** means that all MAC layer frames will be **forwarded** except those matching with any of the specified rules in the following table.
- **BLOCKED** means that all MAC layer frames will be **blocked** except those matching with any of the specified rules in the following table.

You can change the policy by clicking the **Change Policy** button to go to the **Change MAC Filtering Global Policy** page as shown in Figure 4-27.

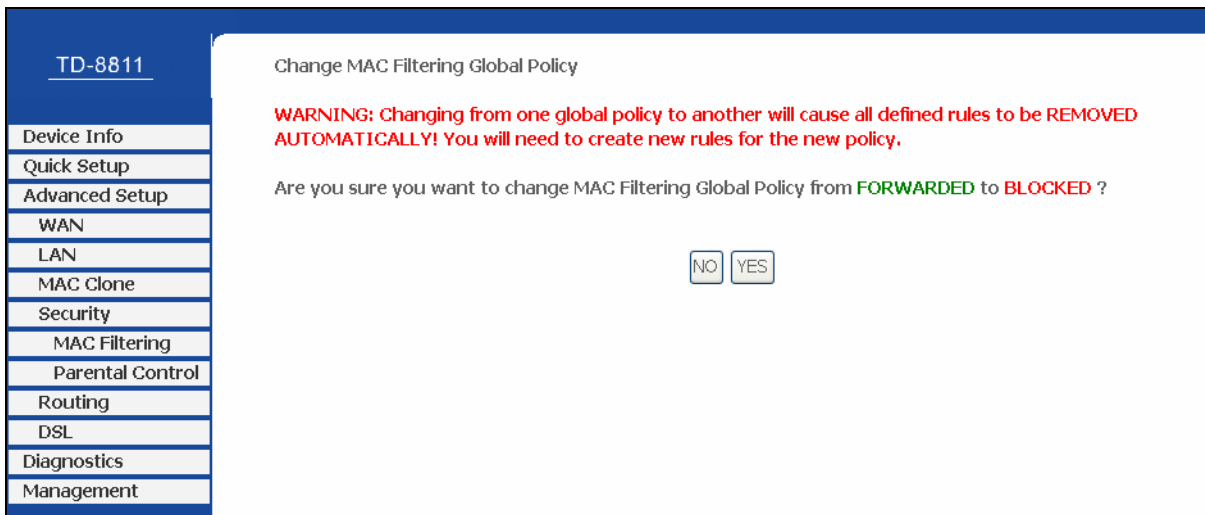

Figure 4-27

To add a new entry, follow the steps below.

1. Click the **Add** button in Figure 4-26 to go to the **Add MAC Filter** page as shown in Figure 4-28.

2. Select the protocol type.
3. Enter the destination MAC address.
4. Enter the source MAC address.
5. Select the frame direction.
6. Select the WAN interfaces.
7. Click **Save/Apply** to save your settings.

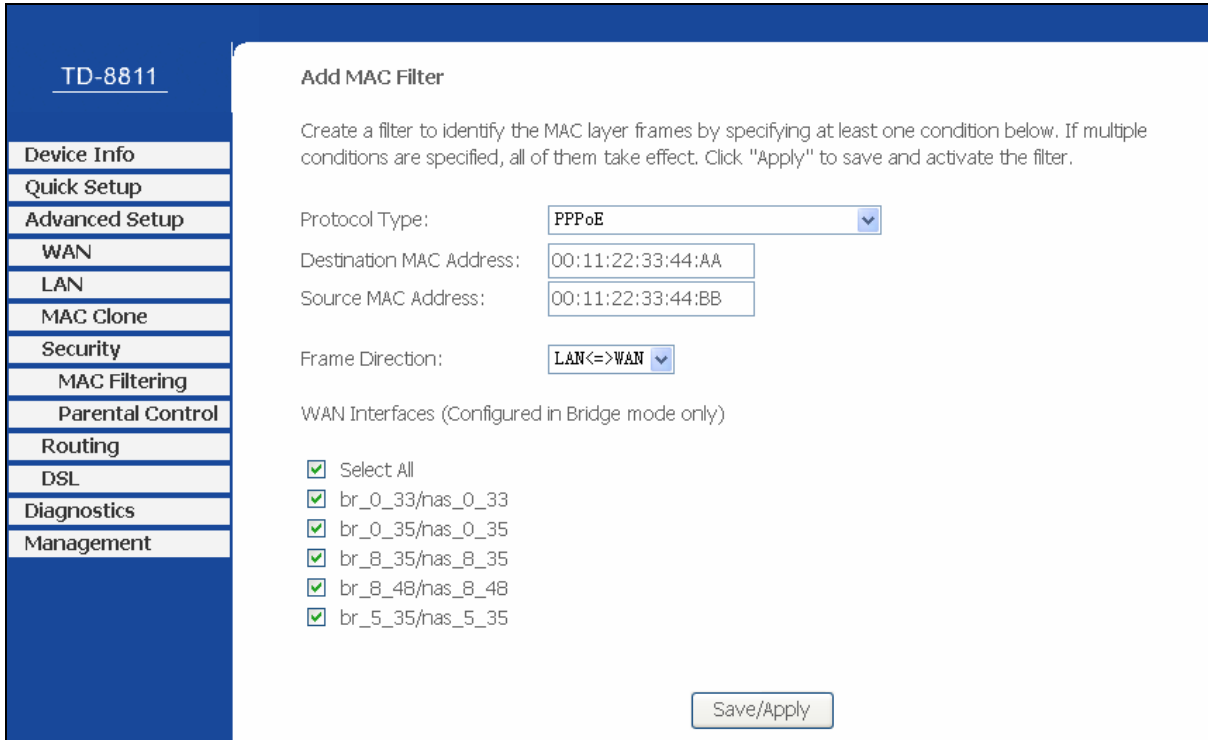

Figure 4-28

To remove an existing entry, follow the steps below.

1. Check the **Remove** box as shown in Figure 4-26 in the entry you want to remove.
2. Click the **Remove** button.

4.3.4.2 Parental Control

Choose “**Security→Parental Control**” menu, you can configure the parental control rule in the screen as shown in Figure 4-29. The Parental Control function can be used to restrict the time of Internet surfing for the child.

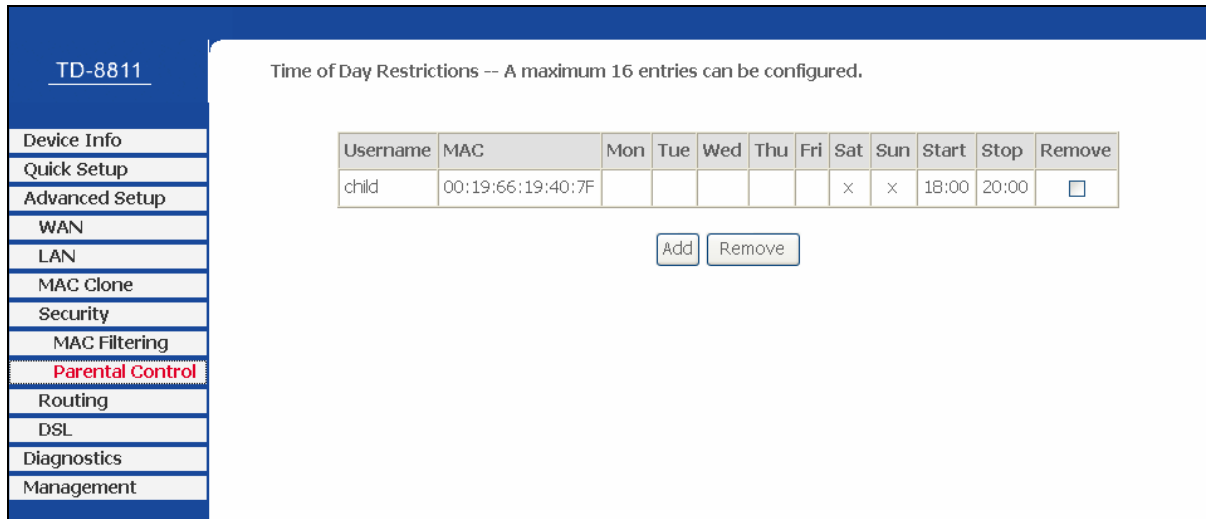

Figure 4-29

For example: If you don't want your child_1 to surf the Internet from 18:00 to 20:00 on weekdays. You can follow the steps below.

1. Click the **Add** button in Figure 4-29 to go to the **Time of Day Restriction** page as shown in Figure 4-30.
2. Create a **User Name** for your child, for example child_1.
3. If you want to restrict the Browser's surfing time, check the **Browser's MAC Address** radio button. If you want to restrict other user's surfing time, check the **Other MAC Address** radio button and enter the MAC address of the user's computer, for example 00:11:22:33:44:CC.
4. Select the day or days you need.
5. Enter the **Start Blocking Time** and **End Blocking Time** both in hh:mm format.
6. Click **Save/Apply** button. Then you will go back to the **Time of Day Restrictions** page and see the list as shown in Figure 4-29.

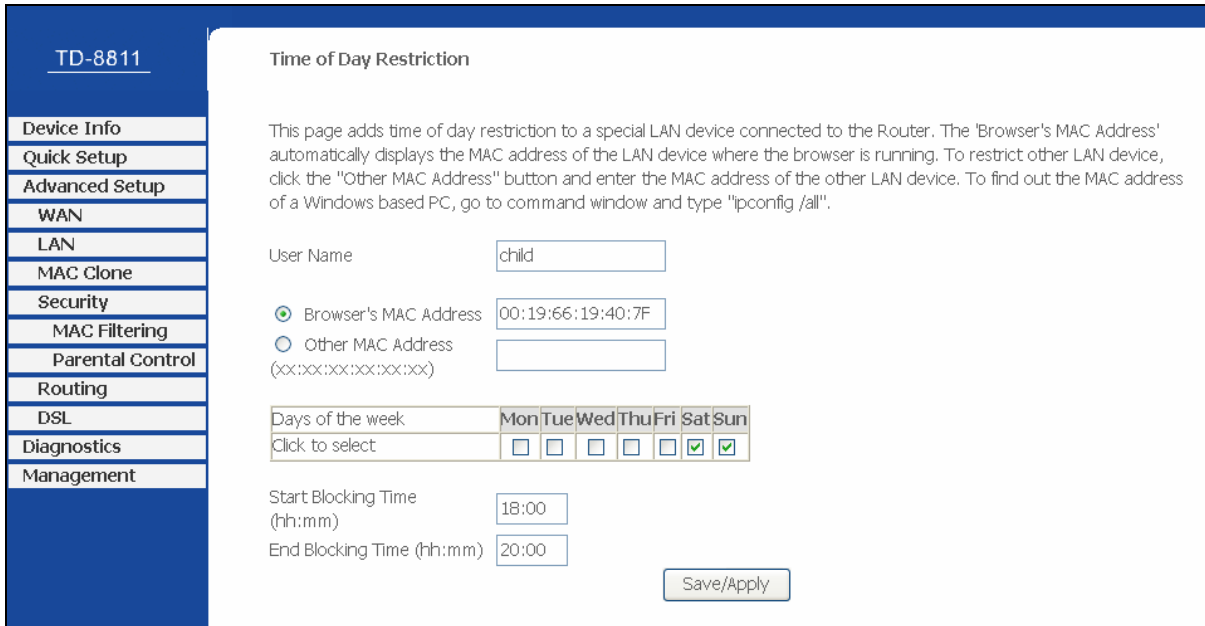

Figure 4-30

To remove an existing entry, follow the steps below.

1. Check the box in the **Remove** column of the entry as shown in Figure 4-29.
2. Click the **Remove** button below.

4.3.5 Routing

Choose “**Advanced Setup**→**Routing**” menu, you can see two submenus under the Routing menu as shown in Figure 4-31.



Figure 4-31

4.3.5.1 Default Gateway

Choose “**Routing**→**Default Gateway**” menu, you can configure the Default Gateway routing in the next screen as shown in Figure 4-32.

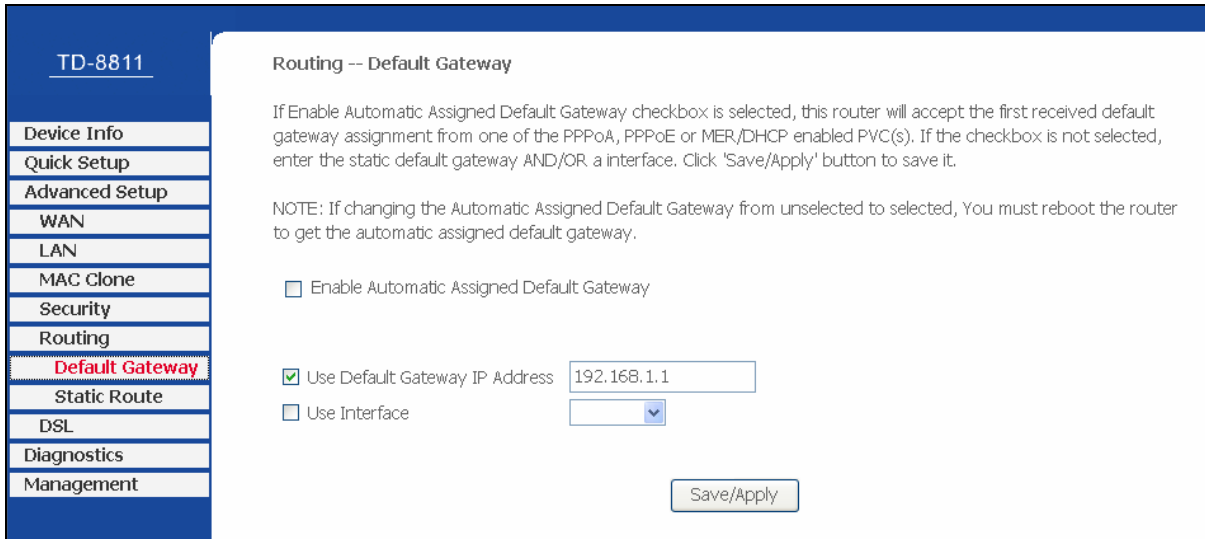

Figure 4-32

- **Enable Automatic Assigned Default Gateway** - Select this checkbox, and then the Router will accept the first received default gateway assignment from one of the PPPoA, PPPoE or MER/DHCP enabled PVC(s). If this checkbox is not selected, you have to enter the static default gateway and/or an interface. Click **Save/Apply** to save your configurations.

Note:

If changing the **Enable Automatic Assigned Default Gateway** from unselected to selected, you must reboot the Router to get the automatic assigned default gateway.

4.3.5.2 Static Route

Choose “**Routing→Static Route**” menu, you can view and add the Static Route entry in the next screen as shown in Figure 4-33. A static route is a pre-determined path that network information must travel to reach a specific host or network.

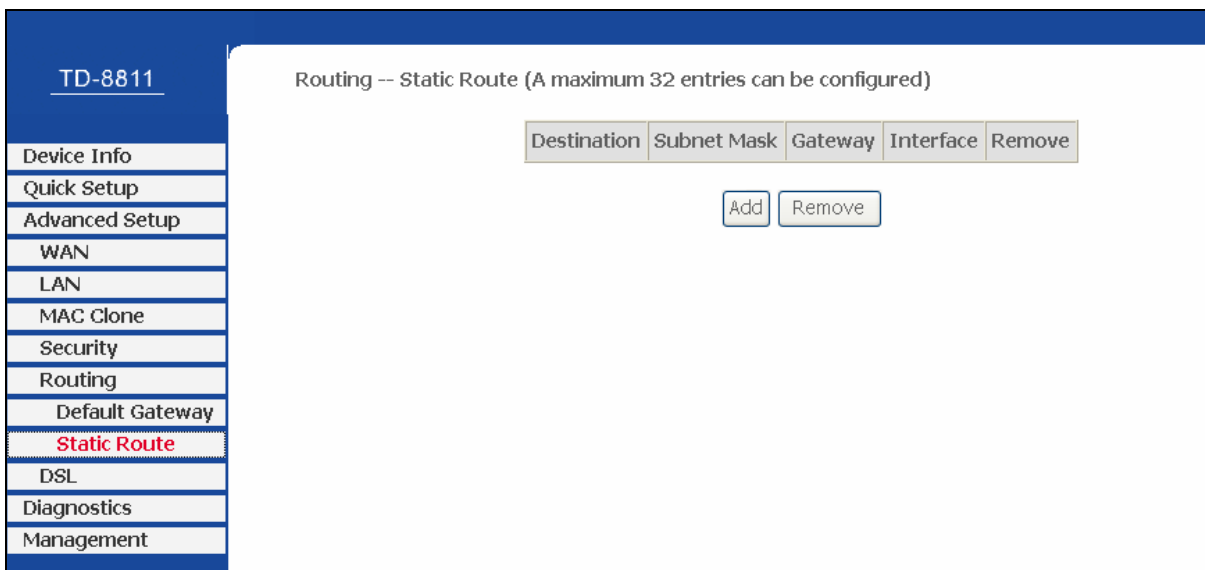

Figure 4-33

To add a new entry, follow the steps below.

1. Click the **Add** button in Figure 4-33 to go to the **Static Route Add** page as shown in Figure 4-34.
2. Enter the IP address of the destination network. This parameter specifies the IP network address of the final destination.
3. Enter the Subnet Mask for the destination.
4. Select the **Use Gateway IP Address** checkbox and enter the IP address of the gateway. The gateway is an immediate neighbor of your ADSL Router that will forward the packet to the destination. On the LAN, the gateway must be a router on the same segment as your Router; over Internet (WAN), the gateway must be the IP address of one of the remote nodes.
5. Click **Save/Apply** to save your configurations. Then you will go back to Figure 4-33 and see your new entry.

Figure 4-34

4.3.6 DSL

Choose “**Advanced Setup**→**DSL**” menu, you can view and configure the parameters in the screen as shown in Figure 4-35.

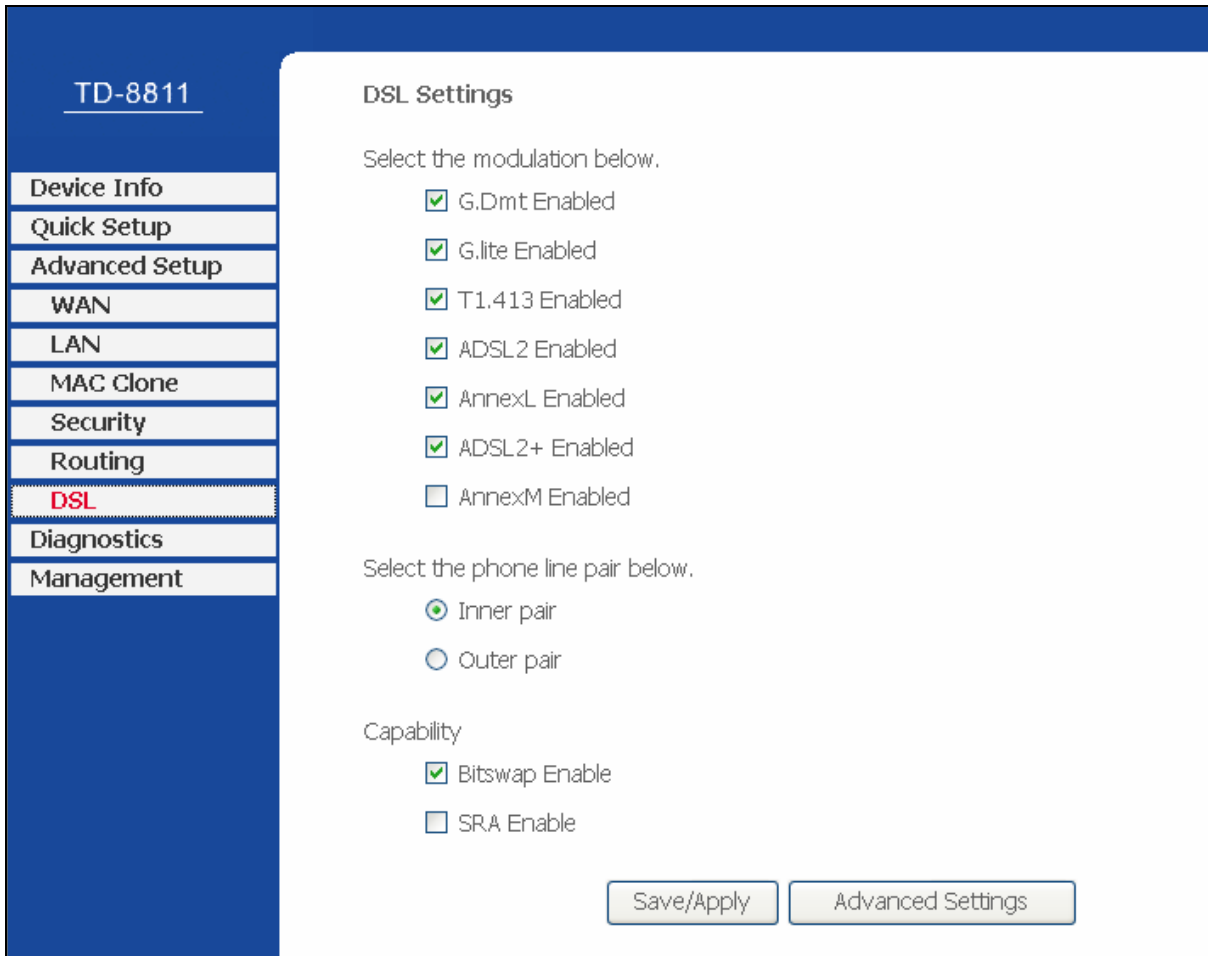

Figure 4-35

If you want to make some advanced settings, click **Advanced Settings** button in Figure 4-35 to go to the **DSL Advanced Settings** page as shown in Figure 4-36.

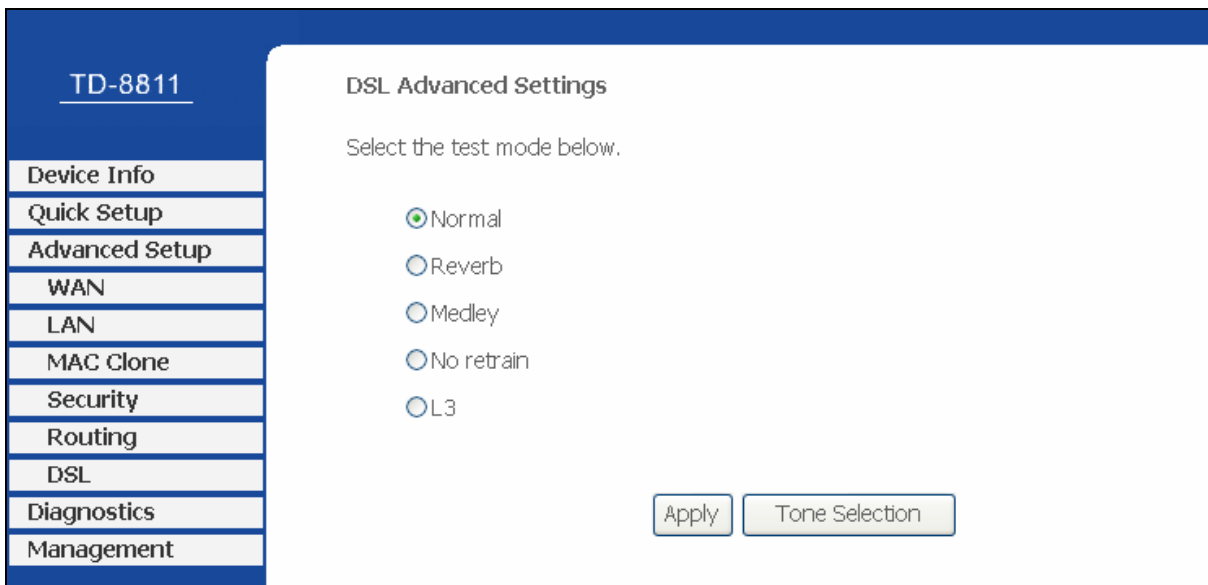

Figure 4-36

If you want to select the tone, click the **Tone Selection** button to go to the ADSL Tone Settings page as shown in Figure 4-37.

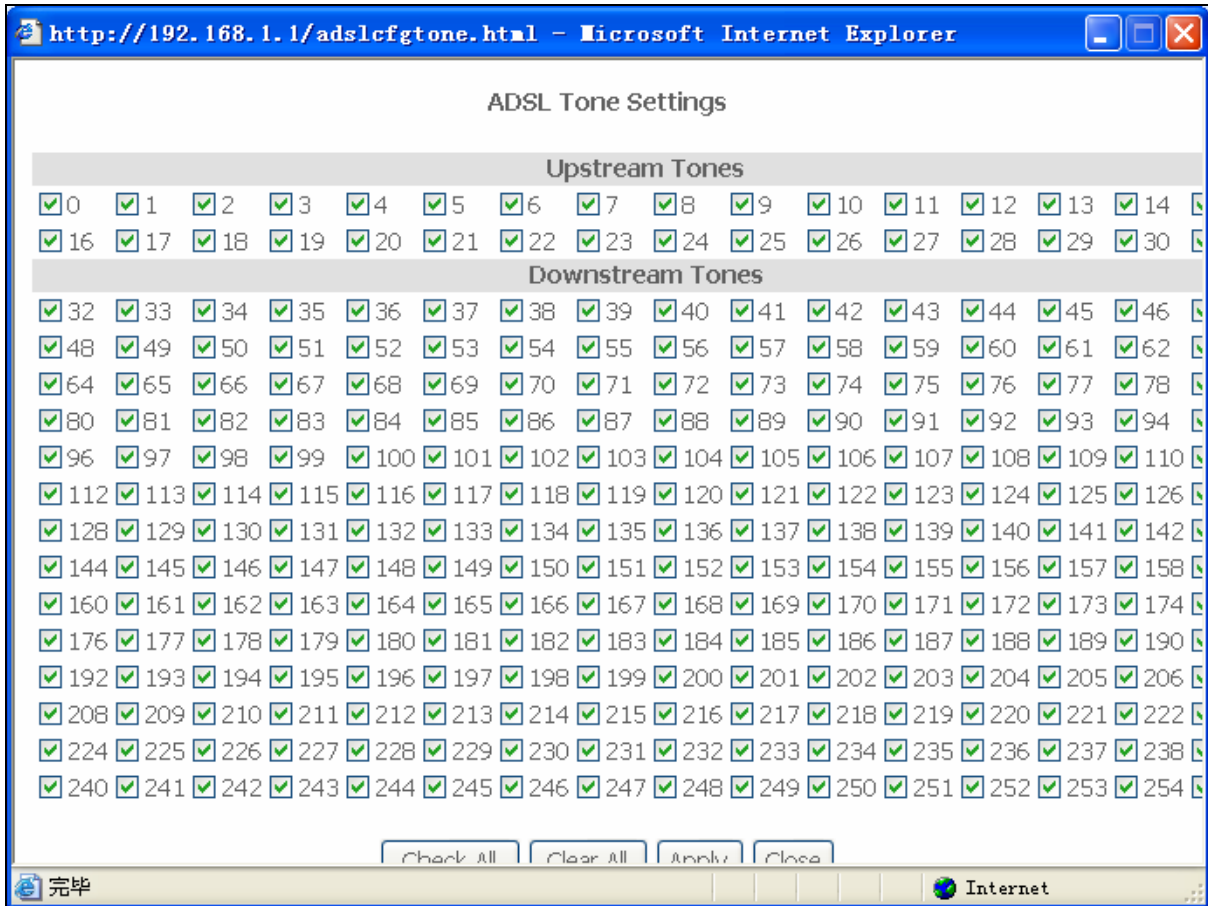

Figure 4-37

4.4 Diagnostics

Choose “**Diagnostics**”, and your modem will test your DSL connection. Then you will see the test results for the connectivity to your local network and your DSL service provider similar to Figure 4-38.

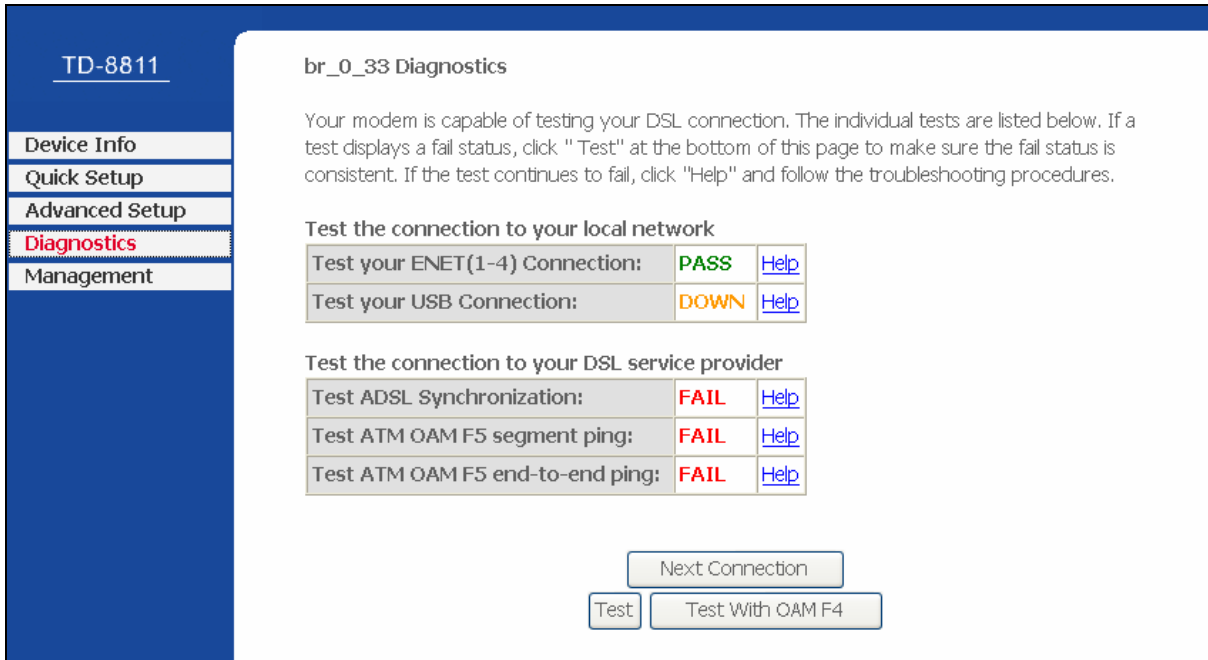

Figure 4-38

4.5 Management

Choose "Management", and you can see the submenus as shown in Figure 4-39.

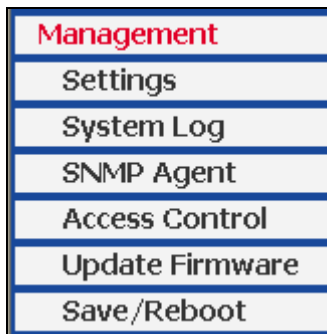

Figure 4-39

4.5.1 Settings

Choose "Management→Settings" menu, and you will see the submenus as shown in Figure 4-40.



Figure 4-40

4.5.1.1 Backup

Choose “**Settings→Backup**” menu, and you can save the current configuration of the Router as a backup file in Figure 4-41. Click **Backup Settings** button to save your current configuration.

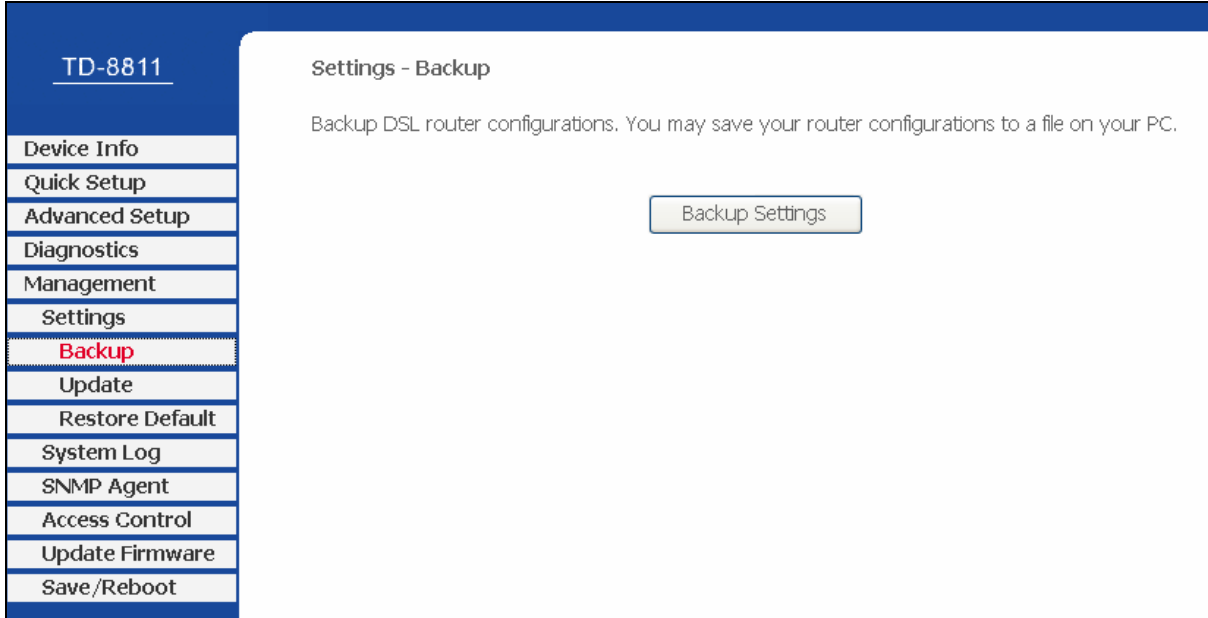

Figure 4-41

4.5.1.2 Update

Choose “**Settings→Update**” menu, and you can update the settings for the Router as shown in Figure 4-42. Click the **Browse...** button to find the file you want to update and then click **Update Settings** to begin the updating.

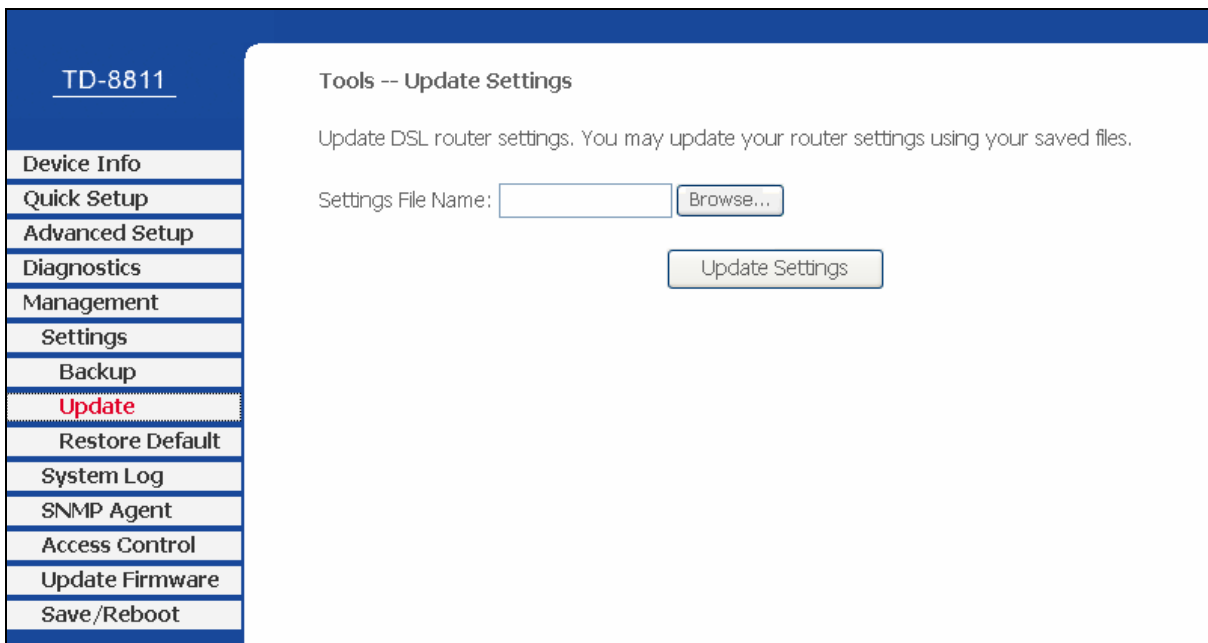

Figure 4-42

4.5.1.3 Restore Default

Choose “**Settings**→**Restore Default**” menu, and you can restore the configurations of the Router to its factory default as shown in Figure 4-43. Click the **Restore Default Settings** button to begin restoring.

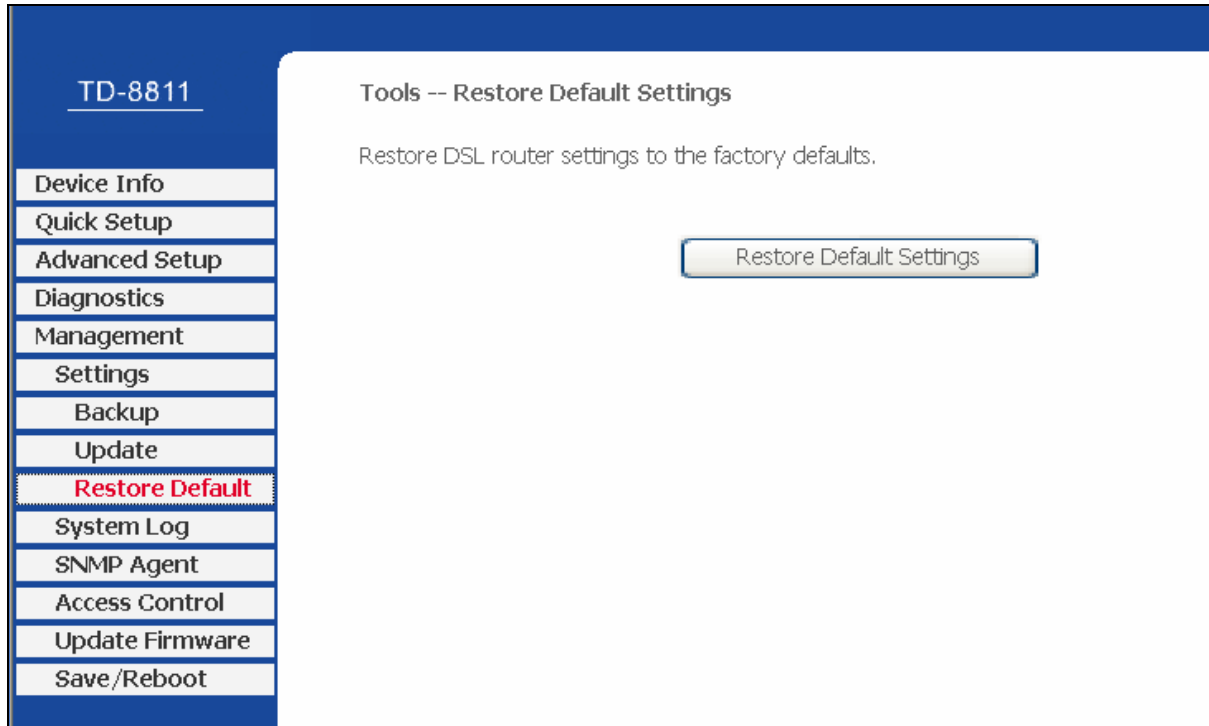

Figure 4-43

4.5.2 System Log

Choose “**Management**→**System Log**” menu, and you can view and configure the logs of the Router in Figure 4-44.

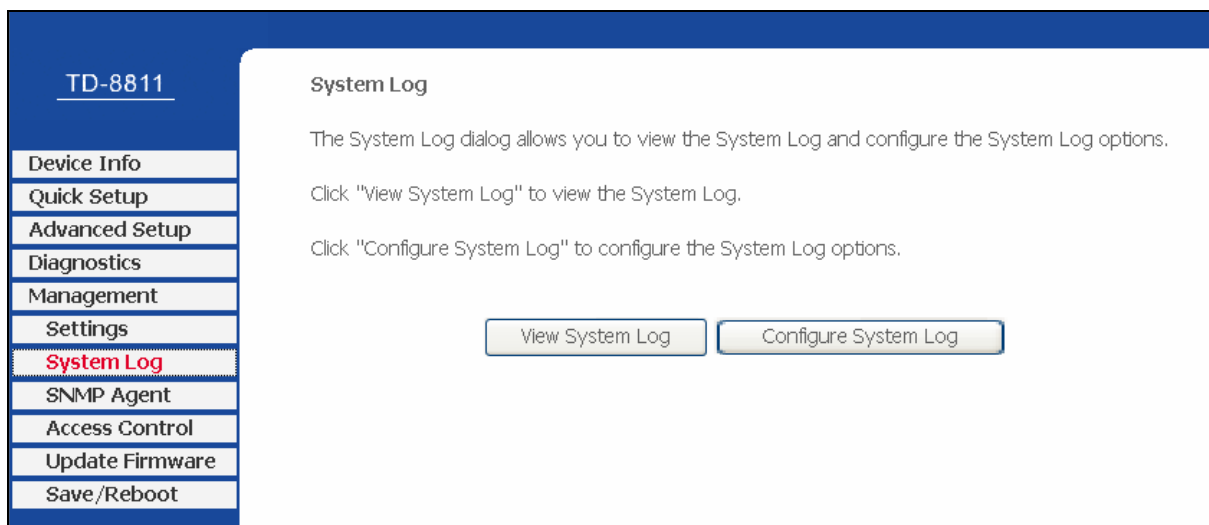

Figure 4-44

Click the **View System Log** button, and you will go to the System Log page and see the logs similar to Figure 4-45.

System Log

Date/Time	Facility	Severity	Message
Jan 1 00:00:12	syslog	emerg	BCM96345 started; BusyBox v1.00 (2009.04.02-13:17+0000)
Jan 1 00:00:13	user	crit	kernel: eth0 Link UP.

Set Refresh Time(Second):

Figure 4-45

Click the **Configure System Log** button, and you will go to the Configuration page as shown in Figure 4-46.

TD-8811

- Device Info
- Quick Setup
- Advanced Setup
- Diagnostics
- Management
- Settings
- System Log**
- SNMP Agent
- Access Control
- Update Firmware
- Save/Reboot

System Log -- Configuration

If the log mode is enabled, the system will begin to log all the selected events. For the Log Level, all events above or equal to the selected level will be logged. For the Display Level, all logged events above or equal to the selected level will be displayed. If the selected mode is 'Remote' or 'Both,' events will be sent to the specified IP address and UDP port of the remote syslog server. If the selected mode is 'Local' or 'Both,' events will be recorded in the local memory.

Select the desired values and click 'Save/Apply' to configure the system log options.

Log: Disable Enable

Log Level:

Display Level:

Mode:

Figure 4-46

- **Log** - Check the **Disable** radio button to disable the system log function. The default setting is enabled.
- **Log Level** - Select the log level, then all the events above or equal to the selected level will be logged.
- **Display Level** - All logged events above or equal to the selected level will be displayed.
- **Mode** - Select Local, Remote or Both. If the selected mode is **Remote** or **Both**, events will be sent to the specified IP address and UDP port of the remote syslog server. If the selected mode is **Local** or **Both**, events will be recorded in the local memory.

4.5.3 SNMP Agent

Choose “**Management→SNMP Agent**” menu, and you will go to the SNMP (Simple Network Management Protocol) page as shown in Figure 4-47. SNMP allows a management application to retrieve statistics and status from the SNMP agent in this device. Select the desired values and click **Save/Apply** to configure the SNMP options.

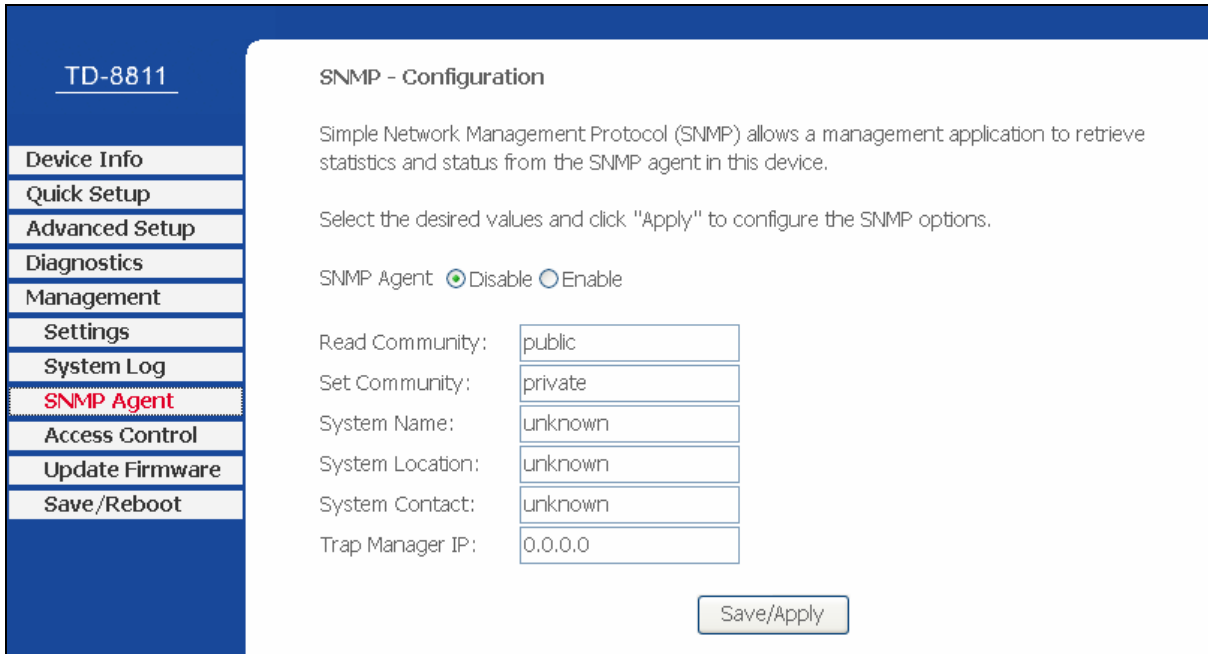

Figure 4-47

4.5.4 Access Control

Choose “**Management→Access Control**” menu, and you will submenus as shown in Figure 4-48.



Figure 4-48

4.5.4.1 Service

Choose “**Access Control→Service**” menu, and you can enable or disable the services as shown in Figure 4-49. Click **Save/Apply** to save your configurations.

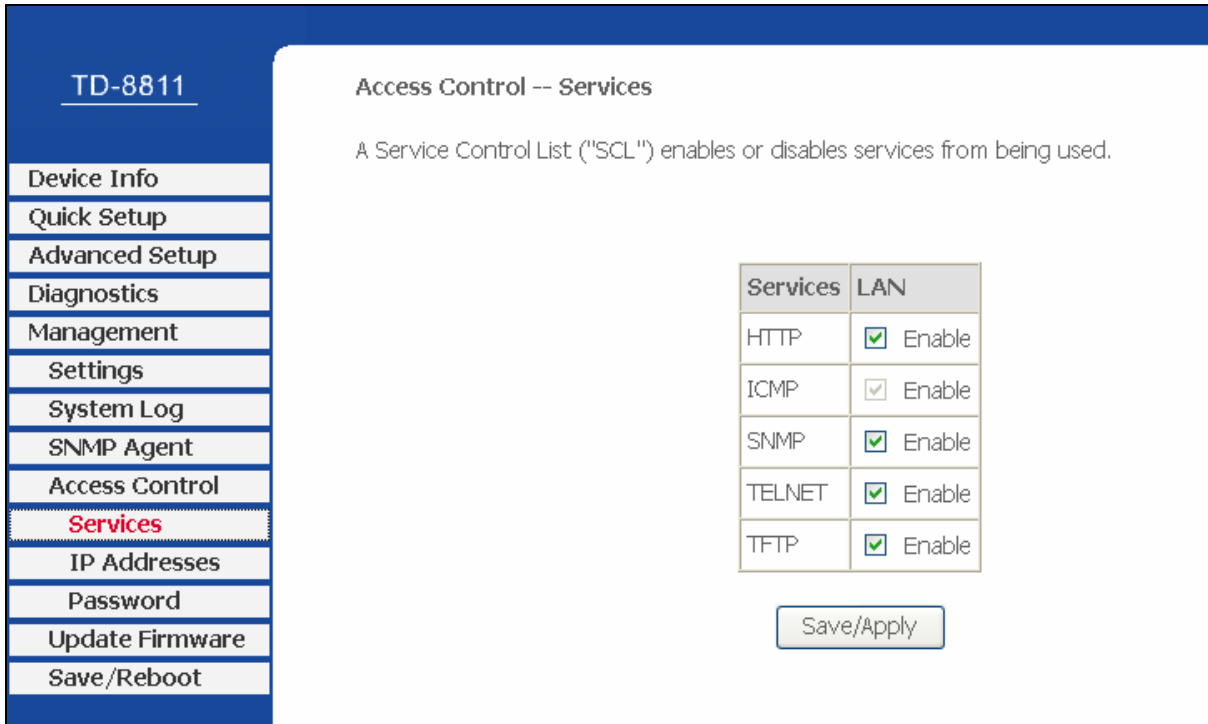

Figure 4-49

4.5.4.2 IP Address

Choose “**Access Control→IP Address**” menu, and can view and configure the IP address access control in the screen as shown in Figure 4-50. If enabled, only PCs with IP addresses listed are allowed to access the Router.

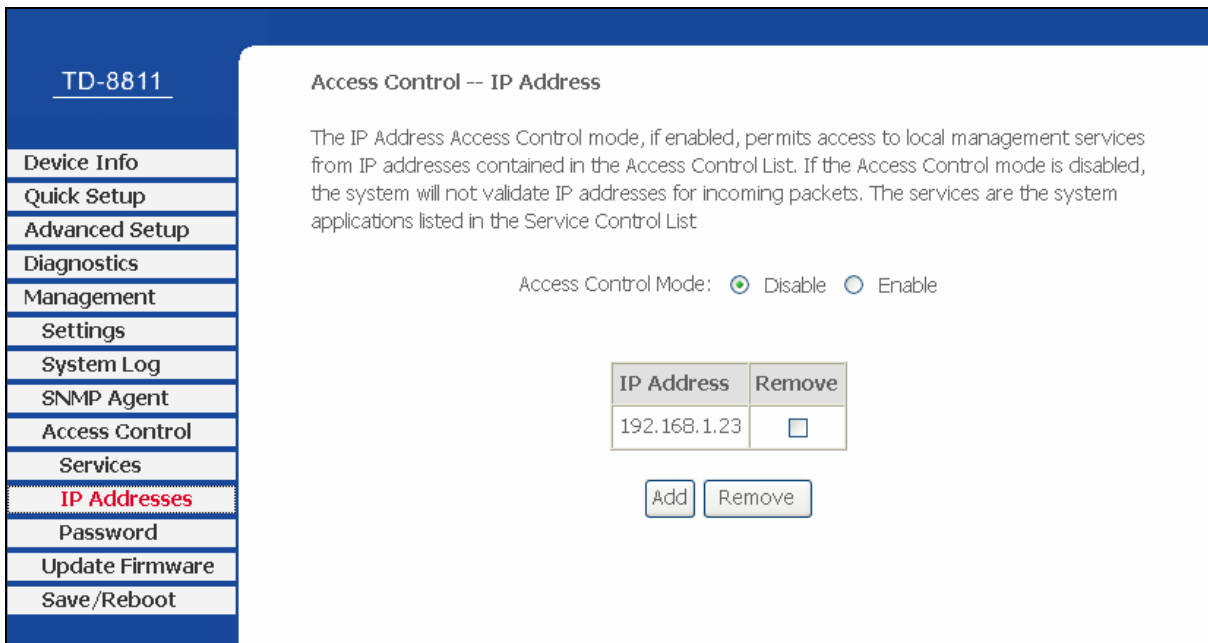

Figure 4-50

To add a new entry, follow the steps below.

1. Click the **Add** button in Figure 4-50 to go to the **Access Control** page in the screen as shown in Figure 4-51.

2. Enter the IP address (e.g. 192.168.1.23) you want to add in the IP Address field.
3. Click **Save/Apply** to save your configuration.

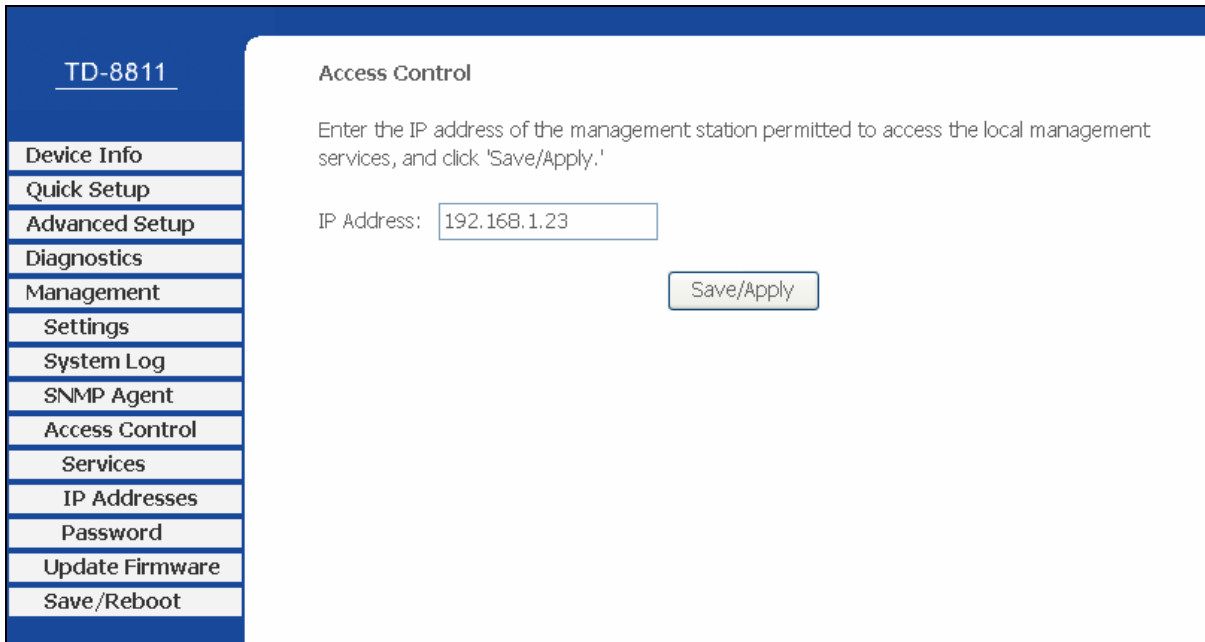

Figure 4-51

4.5.4.3 Password

Choose “**Access Control → Password**” menu, and you can change the factory default password of the Router in the screen as shown in Figure 4-52.

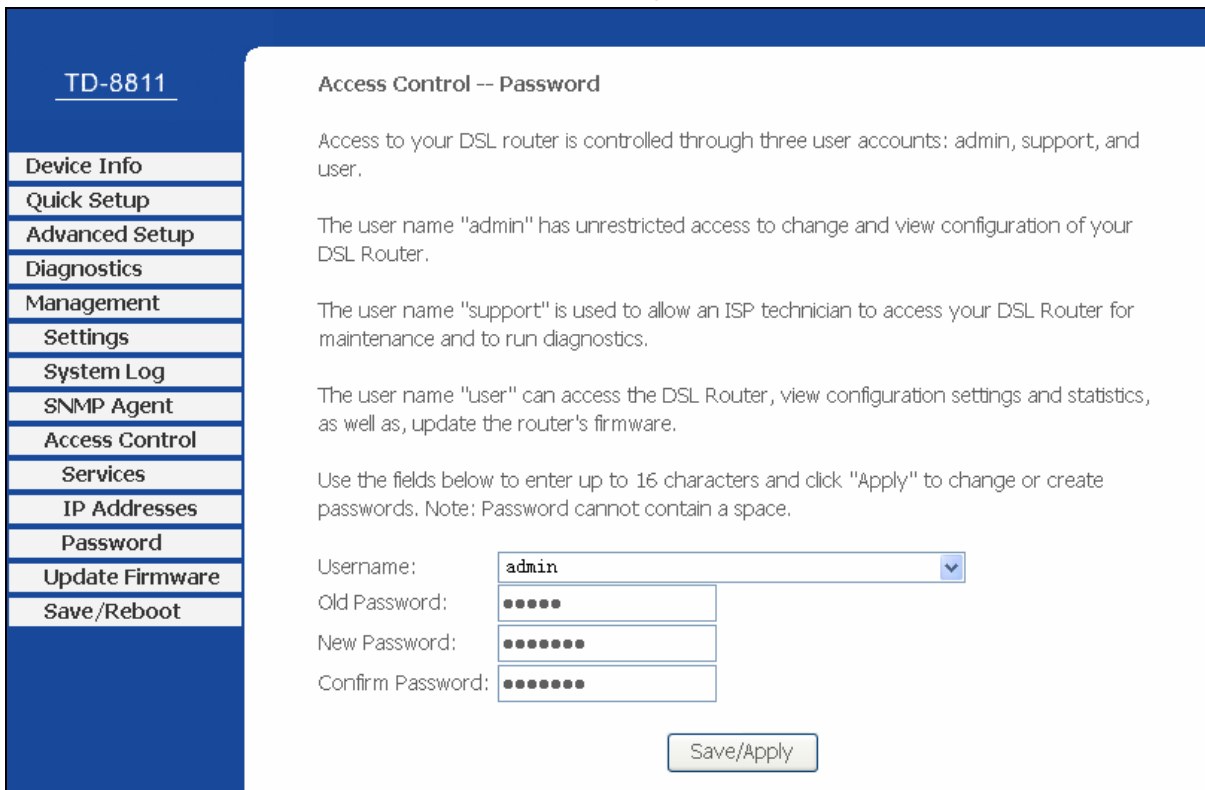

Figure 4-52

4.5.5 Update Firmware

Choose “**Management**→**Update Firmware**” menu, and you can update the latest version of firmware for the Router in the screen as shown in Figure 4-53. Make sure the firmware or romfile you want to use is on the local hard drive of the computer. Click **Browse...** to find the local hard drive and locate the firmware or romfile to be used for upgrade.

The screenshot shows the 'Tools -- Update Firmware' page. On the left is a navigation menu with the following items: Device Info, Quick Setup, Advanced Setup, Diagnostics, Management, Settings, System Log, SNMP Agent, Access Control, **Update Firmware** (highlighted), and Save/Reboot. The main content area has the following text:

Tools -- Update Firmware

Step 1: Obtain an updated firmware image file from your ISP.

Step 2: Enter the path to the image file location in the box below or click the "Browse" button to locate the image file.

Step 3: Click the "Update Firmware" button once to upload the new image file.

NOTE: The update process takes about 2 minutes to complete, and your DSL Router will reboot.

Firmware File Name:

Figure 4-53

To upgrade the router's firmware, follow these instructions below.

- 1 Download a more recent firmware upgrade file from the TP-LINK website (www.tp-link.com).
- 2 Type the path and file name of the update file into the “Firmware File Name” field. Or click the **Browse...** button to locate the update file.
- 3 Click the **Update Firmware** button.

4.5.6 Save/Reboot

Choose “**Management**→**Save/Reboot**” menu, and you can save your configurations and reboot your Router to make the configurations take effect in the screen as shown in Figure 4-54.

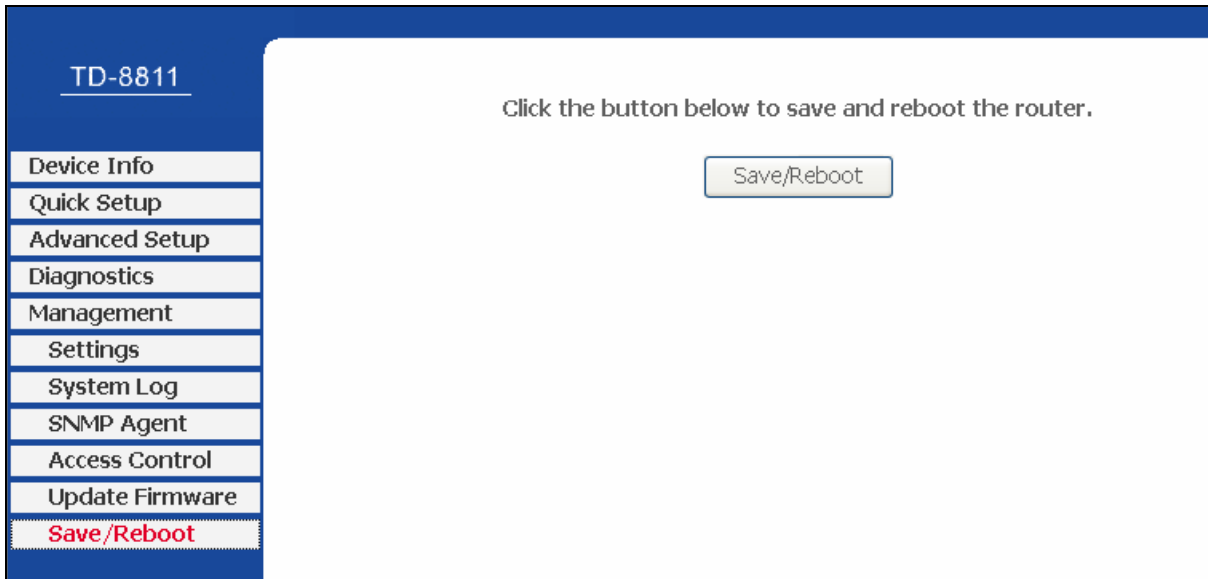

Figure 4-54

Chapter 5. Software Dial

If TD-8811 CPE is working in bridged (RFC 1483 Bridged) mode when connecting to the Internet, you must install dial software on your PC. There are some software working on WINDOWS in market, examples as EnterNet3000、RASPPPoE、WinPeET.

How do I set up the connection in the windows XP?

- The users of Windows XP can click the “**Start→All Programs→Accessories→Communications→New connection wizard**”, and then click **Next** to enter the configuration page.
- Select the “**connect to the Internet**”, and then click the **Next** button to enter the next page. Select the “**set up my connection manually**”, and click **Next** to enter the next page.
- Select the “**connect using a broadband connection that requires user name and password**”. Click **Next** to type the name of your ISP in the current page, and then click **Next**.
- Enter an **ISP account name** and **password**, and click **Next**. If you have forgotten an existing account name or password, please connect with your ISP.
- To create the connection and close this wizard, click **Finish** to add a shortcut to this connection to your desktop.
- When you want to access the Internet by ADSL, double-click this shortcut of dial connection on your desktop. Enter the account name and password, and click **Connect** to connect the Internet.

How do I set up the connection in the Windows Vista?

- Users of Windows Vista can do as follows: Right-press **Network→Choose Properties**, then you can see Figure 5-1.

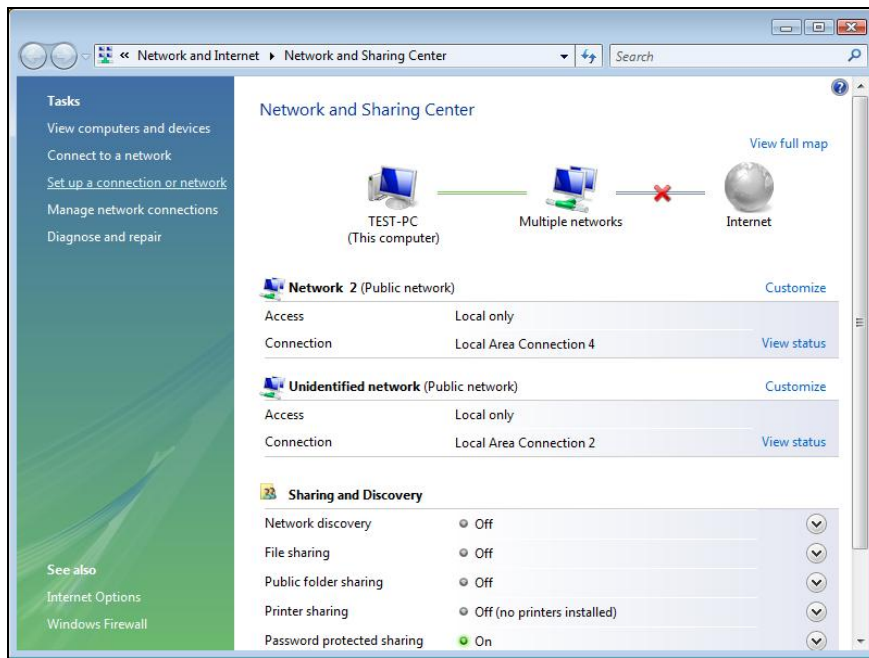

Figure 5-1

- Click **“Set up a connection or network”** in the left of this page. And choose **“Set up a dial-up connection”** in the new page; click **Next**. After that, you will see Figure 5-2; click **“Set up a connection anyway”** to enter next page.

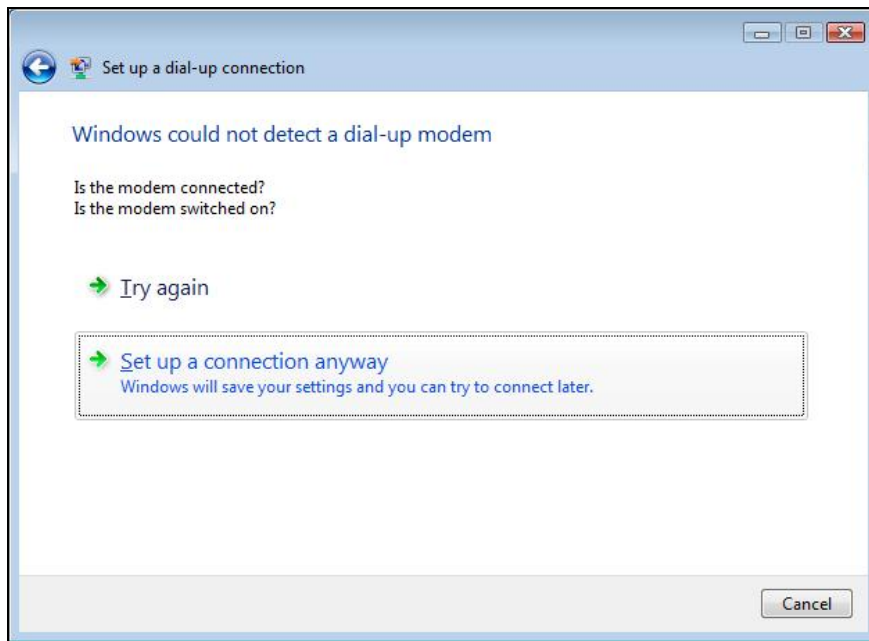

Figure 5-2

- Type the **Dial-up phone number**, the **User name** and **password** supplied by your ISP in the new page. If you have forgotten an existing user name or password, please connect with your ISP. Click **Create** to create the dial-up connection.
- Click **Close** to finish the setup.
- To connect to the Internet next time, click the **Start** button; click **Connect to**, and then click

the connection you just created.

Appendix A: FAQ

1. What related parameters are required to acquire ISP when you want to access the internet by ADSL Router?

- 1) Dial user: Connection protocol, User name, Password, Value of VPI/VCI, Encapsulation mode of AAL5 and so on.
- 2) Static IP user: Connection protocol, WAN IP Address, Subnet Mask, Gateway, Value of VPI/VCI, Encapsulation mode of AAL5 and so on.

2. About Connection protocol, VCI/VPI, Encapsulation mode of AAL5

- 1) This product supports the PPP protocol over ATM (PPPoA)、PPP over Ethernet (PPPoE)、MAC Encapsulation Routing (MER)、IP over ATM (IPoA) and Bridging. You may be used with any one of the five protocols above. Because the ISP in different areas supports different protocol, you must choose the protocol which is supported by your ISP.
- 2) The VPI is the English abbreviation of the Virtual Path Identifier, the VCI is the English abbreviation of the Virtual Channel Identifier, the value of VCI/VPI must be compatible with the value that provided by ISP.
- 3) Encapsulation mode of AAL5 include: LLC/SNAP and VC_MAX(often using LLC/SNAP).

3. Why the LAN's and the NIC's LED both bright, but the configuration interface is inaccessible?

- 1) Use the order of **ping 192.168.1.1** to check the Accuracy of connection.
- 2) Check the Accuracy of working NIC.
- 3) Whatever the setup of the IP address on your computer (if you close the DHCP function, you can't obtain the IP address automatically, must specify the IP address of your computer manually).
- 4) Run the winipcfg order in the windows 95/98(run the ipconfig order in the windows 2000) to check whether setup the IP address, subnet mask, default gateway by DHCP.
- 5) Resume the ADSL Modem default configuration if necessary.

4. Have complete all configurations, but can't dial through computer

- 1) Check the indicator of ADSL, it should be working in normally.
- 2) Check the accuracy of parameter of value of VPI/VCI, Encapsulation mode of AAL5

and so on, whether you need to install the dial software, such as Winpoet, Enternet.

- 3) This product has the PPP dial procedure inside, so you will not need to use the dial software if your protocol is PPPoA or PPPoE, ADSL Modem will connect automatically.
- 4) You can check whether your ADSL Modem succeeds in connection with **PING** command.

Appendix B: Default Config

User name	admin
Password	admin
IP Address	192.168.1.1