

REV.	DESCRIPTION	DRAWN	CHECKED	APPROVED
A	NEW RELEASE	LJH 05/09/05'		

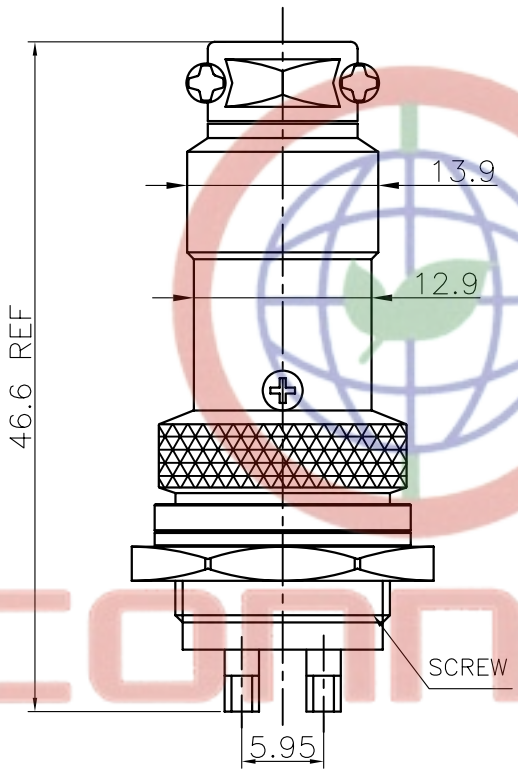

NOTES:

- SPECIFICATION
  - CURRENT RATING: 5A Max.
  - DIELECTRIC WITH STANDING VOLTAGE: 500V(AC)
  - CONTACT RESISTANCE: 50mΩ Max.
  - INSULATION RESISTANCE: 1000MΩ(DC)Min
- PRODUCT NUMBER CODE:

DS1110 - X X X

CONTACT PLATING  
6: TIN

COLOR OF HOUSING:  
W: WHITE  
B: BLACK

No. OF CONTACTS  
2 3 4 5 6 7 8 9

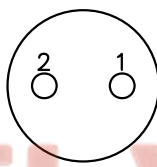

2 PIN

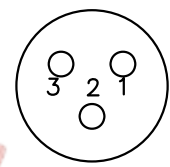

3 PIN

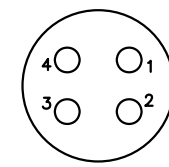

4 PIN

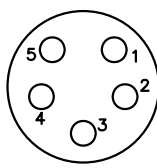

5 PIN

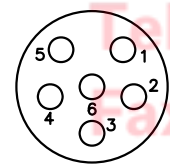

6 PIN

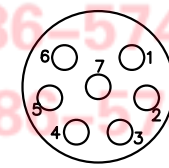

7 PIN

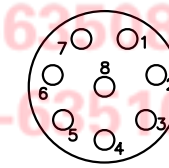

8 PIN

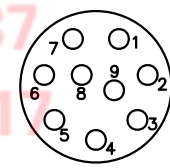

9 PIN

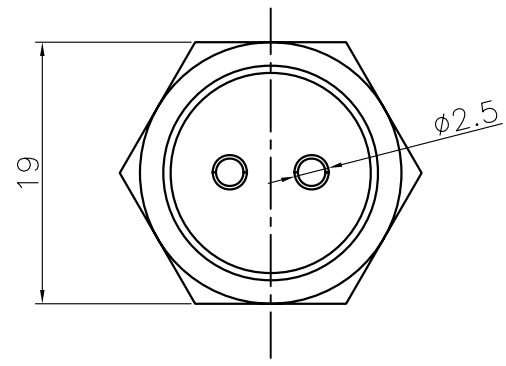

GENERAL TOLERANCE		ANGLE TOLERANCE		PROJECTION		TITLE	MICRO JACK CONNECTOR			
X.	±0.60	X.	±5°	UNITS	mm	SERIES	DS1110 SERIES			
.X	±0.38	.X	±3°	SHEET SIZE	A4					
.XX	±0.25	.XX	±2°							
DRAWING TYPE		CUSTOMER			晨翔电子有限公司 <b>CONNFLY CONNFLY ELECTRONIC CO. LTD</b>					
SCALE		1:1	SHEET						1 OF 1	
DRAWING NO.		C-DS1110-XXX								